

Nordmann AT4 D

Steam generator



OPERATING INSTRUCTIONS

Thank you for choosing Nordmann

Installation date (MM/DD/YYYY):

Commissioning date (MM/DD/YYYY):

Site:

Model:

Serial number:

Proprietary Notice

This document and the information disclosed herein are proprietary data of Condair Group AG. Neither this document, nor the information contained herein shall be reproduced, used, or disclosed to others without the written authorisation of Condair Group AG, except to the extent required for installation or maintenance of recipient's equipment.

Liability Notice

Condair Group AG does not accept any liability due to incorrect installation or operation of the equipment or due to the use of parts/components/equipment that are not authorised by Condair Group AG.

Copyright Notice

© Condair Group AG, All rights reserved.

Technical modifications reserved.

Contents

1	Introduction	4	5.4	Modbus settings	44
1.1	To the very beginning	4	5.4.1	Settings for Modbus networks	44
1.2	Notes on the operating instructions	4	5.4.2	Settings for the communication with the optional remote terminal	45
2	For your safety	6	5.5	Diagnostic functions	46
3	Product Overview	8	5.5.1	Interrogation of the error history	46
3.1	Models overview	8	5.5.2	Interrogation of unit information	47
3.2	Identification of the unit	9	5.5.3	Performing remote steam bath tests	48
3.3	Steam generator construction	10	5.5.4	Performing remote relay tests	49
3.4	Functional description	11	5.5.5	Performing Module tests	49
3.5	Humidification system overview	13	5.6	Working with the remote terminal	50
4	Operation	14	5.6.1	Menu overview remote terminal	50
4.1	Commissioning	14	5.6.2	Remote terminal settings	51
4.2	Notes on operation	15	5.6.2.1	Selecting the dialogue language	51
4.2.1	Function of the display and operating elements	15	5.6.2.2	Setting the number of steam generators connected to the remote terminal	51
4.2.2	Remote operating and fault indication	16	5.6.2.3	Interrogation of the error history of the remote terminal	51
4.2.3	Notes on the operation at ambient temperatures $\leq 0^{\circ}\text{C}$	16	5.6.2.4	Resetting the error history list of the remote terminal	52
4.2.4	Inspections during operation	16	5.6.2.5	Setting the baudrate	52
4.3	Carrying out manual draining	17	5.6.2.6	Setting the display contrast	52
4.4	Taking the unit out of operation	17	6	Maintenance	53
5	Working with the unit control	18	6.1	Important notes on maintenance	53
5.1	Operating the control unit and menu overview	18	6.2	Maintenance list	54
5.2	Basic steam bath settings	20	6.3	Removing and installing parts for maintenance	55
5.2.1	Setting the temperature setpoint (steam bath operation) or humidity setpoint (caldarium operation)	20	6.3.1	Removal and installation of the steam cylinder	55
5.2.2	Setting the control mode	20	6.3.2	Removal and installation of the drain cup	58
5.2.3	Setting the steam bath time	21	6.3.3	Removal and installation of the water cup and the water hoses	59
5.2.4	Configuring the fragrance pump(s)	21	6.3.4	Removal and installation of the drain pump	60
5.2.5	Switching the effect light (Light-2) on and off	22	6.3.5	Removal and installation of the inlet valve	61
5.3	Unit settings in the user settings menu	23	6.3.6	Removal and installation of the cylinder receptacle	62
5.3.1	Launching the user settings menu	23	6.4	Notes on cleaning the unit components	63
5.3.2	Selecting the dialogue language	23	6.5	Notes on cleaning agents	65
5.3.3	Steam bath control settings	23	6.6	Resetting the maintenance indication	65
5.3.3.1	Setting the operation mode	24	7	Fault elimination	66
5.3.3.2	Configuring week timer	24	7.1	Fault indication	66
5.3.3.3	Setting the maximum heating time for week timer operation	25	7.2	Malfunction lists	67
5.3.3.4	Fan control settings	26	7.2.1	System faults	67
5.3.3.5	Fragrance pump control settings	30	7.2.2	Unit faults	68
5.3.3.6	Light control settings	30	7.3	Faults without fault indication	70
5.3.3.7	Sensor signal settings	31	7.4	Notes on fault elimination	71
5.3.3.8	Setting the controller type	35	7.5	Resetting the error indication (red LED lights)	71
5.3.3.9	Setting the proportional range for the internal P/PI controller	35	7.6	Replacing the backup battery on the control board	72
5.3.3.10	Setting the integral time for the internal PI controller	35	8	Taking out of service/Disposal	73
5.3.3.11	Configuring the Quasi On/Off control	36	8.1	Taking out of service	73
5.3.3.12	Setting the maximum door opening time	36	8.2	Disposal/Recycling	73
5.3.4	Selecting the cylinder type	37	9	Product specifications	74
5.3.5	Configuring the SC system	37	9.1	Technical data	74
5.3.5.1	Activating/deactivating the SC system	37	9.2	Wiring diagram Nordmann AT4 D	75
5.3.5.2	Setting the operation time of the SC-Pump	38			
5.3.6	Configuring the capacity limitation	38			
5.3.7	Water management settings	39			
5.3.7.1	Selecting the conductivity range of the supply water	39			
5.3.7.2	Setting the drain factor	39			
5.3.7.3	Setting the operating mode for standby operation	40			
5.3.7.4	Activating/Deactivating the forced draining	42			
5.3.7.5	Setting the time of operation after which a forced draining takes place	43			
5.3.8	Setting the date	43			
5.3.9	Setting the time	43			
5.3.10	Setting the display contrast	43			

1 Introduction

1.1 To the very beginning

We thank you for having purchased the **steam generator Nordmann AT4 D**.

The steam generator Nordmann AT4 D incorporates the latest technical advances and meets all recognized safety standards. Nevertheless, improper use of the Nordmann AT4 D may result in danger to the user or third parties and/or impairment of material assets.

To ensure a safe, proper, and economical operation of the steam generator Nordmann AT4 D, please observe and comply with all information and safety instructions contained in the present operating instructions.

If you have questions, which are not or insufficiently answered in this documentation, please contact your Nordmann supplier. They will be glad to assist you.

1.2 Notes on the operating instructions

Limitation

The subject of these operating instructions is the steam generator Nordmann AT4 D. The various accessories are only described insofar as this is necessary for proper operation of the equipment. Further information on accessories can be obtained in the respective instructions.

These operating instructions are restricted to the **commissioning, operation, servicing and trouble shooting** of the steam generator Nordmann AT4 D and is meant for **well trained personnel being sufficiently qualified for their respective work**.

These operating instructions are supplemented by various separate items of documentation (installation instructions, spare parts list, manuals for accessories, etc.). Where necessary, appropriate cross-references are made to these publications in the present documentation.

Explanation of the symbols used in this manual

CAUTION!

The catchword "CAUTION" designates notes in this documentation that, if neglected, may cause **damage and/or malfunction of the unit or other material assets**.



WARNING!

The catchword "WARNING" used in conjunction with the general caution symbol designates safety and danger notes in this documentation that, if neglected, may cause to **injury to persons**.



DANGER!

The catchword "DANGER" used in conjunction with the general caution symbol designates safety and danger notes in this documentation that, if neglected, may lead to **severe injury or even death of persons**.

Safekeeping

Please safeguard these operating instructions in a safe place, where it can be immediately accessed. If the equipment changes hands, the documentation should be passed on to the new operator.

If the documentation gets mislaid, please contact your Nordmann supplier.

Language versions

The present operating instructions are available in various languages. Please contact your Nordmann supplier for information.

Copyright protection

The present operating instructions are protected under the Copyright Act. Passing-on and reproduction of the manual (or part thereof) as well as exploitation and communication of the contents are prohibited without written permission by the manufacturer. Violation of copyright terms is subject to legal prosecution and arises liability for indemnification.

The manufacturer reserves the right to fully exploit commercial patent rights.

2 *For your safety*

General

Every person working with the Nordmann AT4 D must have read and understood the present operating instructions before carrying out any work. Knowing and understanding the contents of the operating instructions is a basic requirement for protecting the personnel against any kind of danger, to prevent faulty operation, and to operate the unit safely and correctly.

All ideograms, signs and markings applied to the unit must be observed and kept in readable state.

Qualification of personnel

All actions described in the present operating instructions (operation, maintenance, etc.) must be carried out only by **well trained and sufficiently qualified personnel authorised by the owner**.

For safety and warranty reasons any action beyond the scope of this manuals must be carried out only by qualified personnel authorised by the manufacturer.

It is assumed that all persons working with the Nordmann AT4 D are familiar and comply with the appropriate regulations on work safety and the prevention of accidents.

This unit may not be used by persons (including children) with reduced physical, sensory or mental abilities or persons with lacking experience and/or knowledge, unless they are supervised by a person responsible for their safety or they received instructions on how to operate the unit.

Children must be supervised to make sure that they do not play with unit.

Intended use

The steam generator Nordmann AT4 D is intended exclusively for generation of steam for a steam bath within the specified operating conditions (see chapter 9 "Product specifications"). Any other type of application without the express written consent of the manufacturer is considered as not conforming with the intended purpose and may lead to the Nordmann AT4 D becoming dangerous.

Operation of the equipment in the intended manner requires **that all the information in these instructions is observed (in particular the safety instructions)**.

Danger that may arise from the unit



DANGER!
Danger of electric hazard!

The Nordmann AT4 D is mains powered. One may get in touch with live parts when the unit is open. Touching live parts may cause severe injury or danger to life.

Prevention: Before carrying out any work set the Nordmann AT4 D out of operation as described in chapter 4.4 (switch off the unit, disconnect it from the mains and stop the water supply) and secure the unit against inadvertent power-up.



WARNING!
Hot water vapour - Danger of scalding!

The Nordmann AT4 D produces hot water vapour. There is danger of scalding when getting in touch with hot water vapour.

Prevention: Do not carry out any work on the steam system during operation (steam lines, steam distributor, etc.). If the steam system is leaky set the Nordmann AT4 D immediately out of operation as described in chapter 4.4. Correctly seal the steam system before putting the unit into operation again.



WARNING!
Danger of burning!

During operation the components of the steam system (steam cylinder, steam distributor, etc.) get very hot (up to 100 °C). There is danger of burning when touching the hot components.

Prevention: Before carrying out any work on the steam system set the Nordmann AT4 D out of operation as described in chapter 4.4, then wait until the components have cooled down sufficiently thus preventing danger of burning.

Behaviour in case of danger

If it is suspected that **safe operation is no longer possible**, then the Nordmann AT4 D should immediately **be shut down and secured against accidental power-up according to chapter 4.4**. This can be the case under the following circumstances:

- if the Nordmann AT4 D is damaged
- if the electrical installations are damaged
- if the Nordmann AT4 D is no longer operating correctly
- if connections and/or piping are not sealed

All persons working with the Nordmann AT4 D must report any alterations to the unit that may affect safety to the owner without delay.

Prohibited modifications to the unit

No modifications must be undertaken on the Nordmann AT4 D without the express written consent of the manufacturer.

For the replacement of defective components use exclusively **original accessories and spare parts** available from your Nordmann supplier.

3 Product Overview

3.1 Models overview

Steam generators Nordmann AT4 D are available with **different heating voltages** and **steam capacities ranging from 5 kg/h up to a maximum of 65 kg/h.**

Heating voltage **	Max. steam capacity in kg/h	Model Nordmann AT4 D	Unit size		
			small	medium	large
400V3 (400 V/3~/50...60 Hz)	5	534	x		
	8	834	x		
	15	1534		x	
	23	2364		x	
	32	3264			x
	45	4564			x
	65	6564			x
400V2 (400 V/2~/50...60 Hz)	5	524	x		
	8	824	x		
230V3 (230 V/3~/50...60 Hz)	5	532	x		
	8	832	x		
	15	1532		x	
	23	2362		x	
	32	3262			x
230V1 (230 V/1~/50...60 Hz)	5	522	x		
	8	822	x		

** Other heating voltages on request

Key model designation

Example:

Nordmann AT4 D 4564 400V3

Product designation: _____

Unit model: _____

Heating voltage: _____

400V/3~/50...60Hz: **400V3**

400V/2~/50...60Hz: **400V2**

230V/3~/50...60Hz: **230V3**

230V/1~/50...60Hz: **230V1**

3.2 Identification of the unit

The identification of the unit is found on the type plate:

	Type designation	Serial number (7 digits)	Month/Year
	Condair Group AG, Gwattstrasse 17, 8808 Pfäffikon SZ, Switzerland		
Heating voltage	Type: AT4 D 4564	Ser.Nr.: XXXXXXX	02.10
Maximum steam capacity per unit	Heating voltage: 400V / 3~ / 50...60Hz	Power: 33.8 kW	
Admissible water supply pressure	Steam capacity: 45.0 kg/h	Ctrl. Voltage: 230V / 1~ / 50...60Hz	
Field with certification symbols	Water pressure: 1...10 bar		
Power consumption			
Control voltage			
	Engineered in Switzerland, Made in Germany		

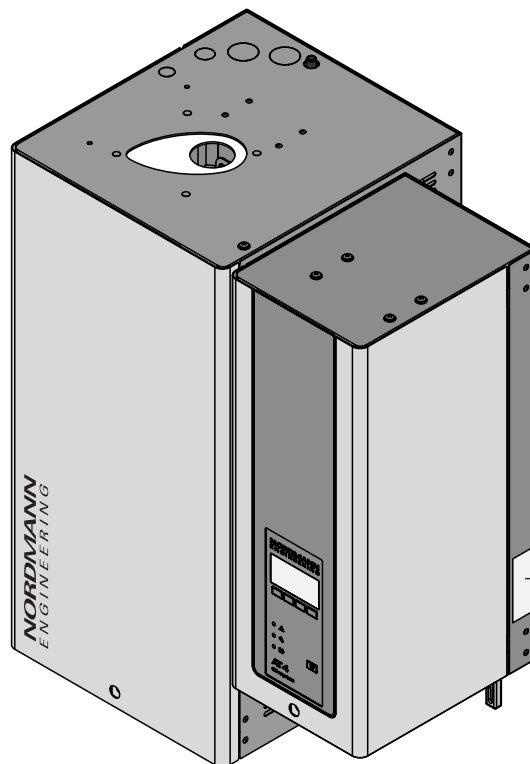

3.3 Steam generator construction

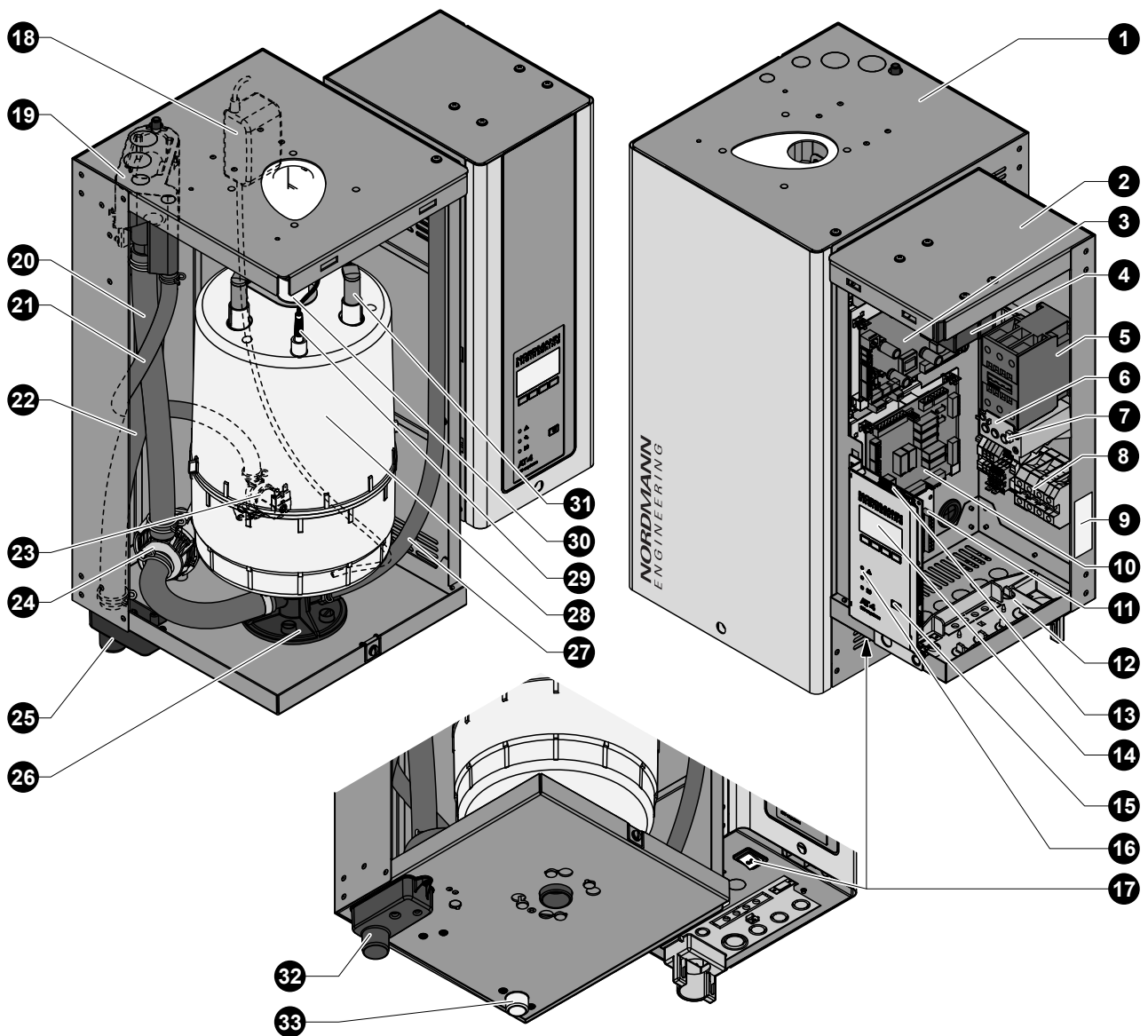
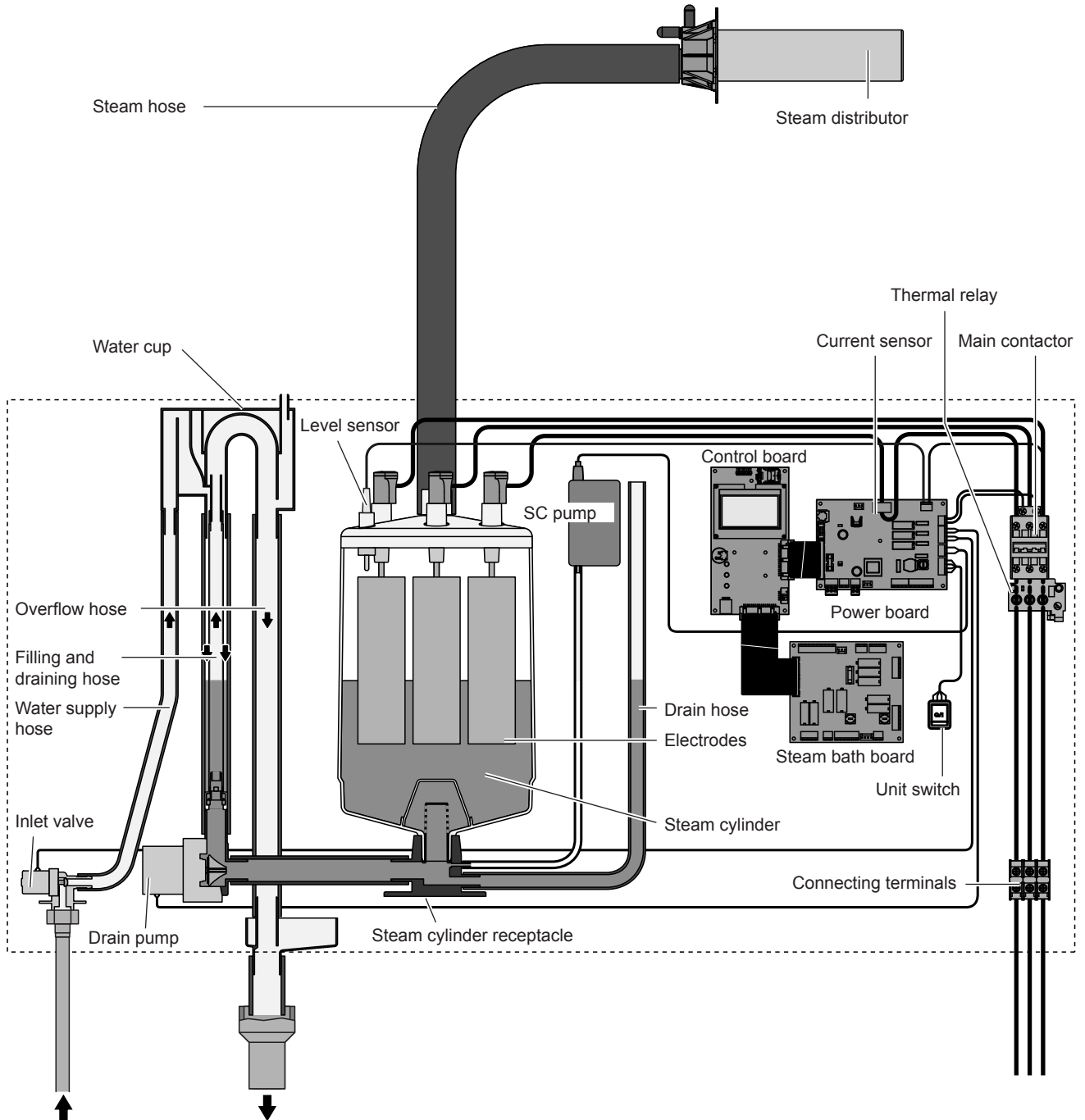

figure shows medium unit

- | | |
|----------------------------------------------------------------------------------------------|------------------------------|
| 1 Steam cylinder compartment (small, medium, large) | 17 Unit switch |
| 2 Control compartment | 18 SC pump |
| 3 Power board | 19 Water cup |
| 4 Transformer (Option) | 20 Filling and draining hose |
| 5 Main contactor | 21 Water supply hose |
| 6 Thermal relay | 22 Overflow hose |
| Note: on some unit models the thermal relay is not connected directly to the main contactor! | 23 Inlet valve |
| 7 Reset key thermal relay | 24 Drain pump |
| 8 Connecting terminals | 25 Drain cup |
| 9 Type plate | 26 Steam cylinder receptacle |
| 10 Steam bath board | 27 Drain hose (manual drain) |
| 11 Remote operating and fault indication board (option) | 28 Steam cylinder |
| 12 Cable openings | 29 Level sensor |
| 13 Control board with CF Card | 30 Steam outlet |
| 14 Display and control unit | 31 Electrode plug |
| 15 Drain key | 32 Drain connector |
| 16 Operation status indicators | 33 Water supply connector |

3.4 Functional description

The steam generator Nordmann AT4 D is a pressureless steam generator that utilizes an electrode heating. The steam generator Nordmann AT4 D is designed for steam generation for steam baths.



Steam generation

Any time steam is requested, the electrodes are supplied with voltage via main contactor. Simultaneously, the inlet valve opens and water enters the steam cylinder from the bottom via water cup and supply line. As soon as the electrodes come in contact with the water, current begins to flow between the electrodes, eventually heating and evaporating the water. The more the electrode surface is exposed to water, the higher is the current consumption and thus the steam capacity.

Upon reaching the requested steam capacity, the inlet valve closes. If the steam generation decreases below a certain percentage of the required capacity, due to lowering of the water level (e.g. because of the evaporation process or drainage), the inlet valve opens until the required capacity is available again.

If the required steam capacity is lower than the actual output, the inlet valve is closed until the desired capacity is achieved by lowering of the water level (evaporation process).

Level monitoring

A sensor provided in the steam cylinder cover detects when the water level gets too high. The moment the sensor comes in contact with water, the inlet valve closes.

Drainage

As a result of the evaporation process, the conductivity of the water increases due to an escalating mineral concentration. Eventually, an inadmissibly high current consumption would take place if this concentration process were permitted to continue. To prevent this concentration from reaching a value, unsuitably high for the operation, a certain amount of water is periodically drained from the cylinder and replaced by fresh water.

Lime management

The interval controlled SC pump blows air into the steam cylinder. Thus keeping the solved minerals in the water in motion as a result they are discharged with the automatic drain cycles.

Maximum current monitoring

The thermal relay monitors the current flow to the electrodes. If the current exceeds a preset value the thermal relay triggers and interrupts the control voltage supply whereby the Nordmann AT4 D is switched off.

When the thermal relay has triggered it can be reset after a certain period of time via the reset key.

Control steam production

The steam production is controlled steplessly (continuous control) by the KTY temperature sensor (for steam bath operation) or by a humidity sensor (for caldarium operation) and the integrated continuous controller.

Steam bath control

The control of the steam bath components (light, fans, fragrance pumps, bench heating, etc.) is established via the integrated steam bath board.

3.5 Humidification system overview

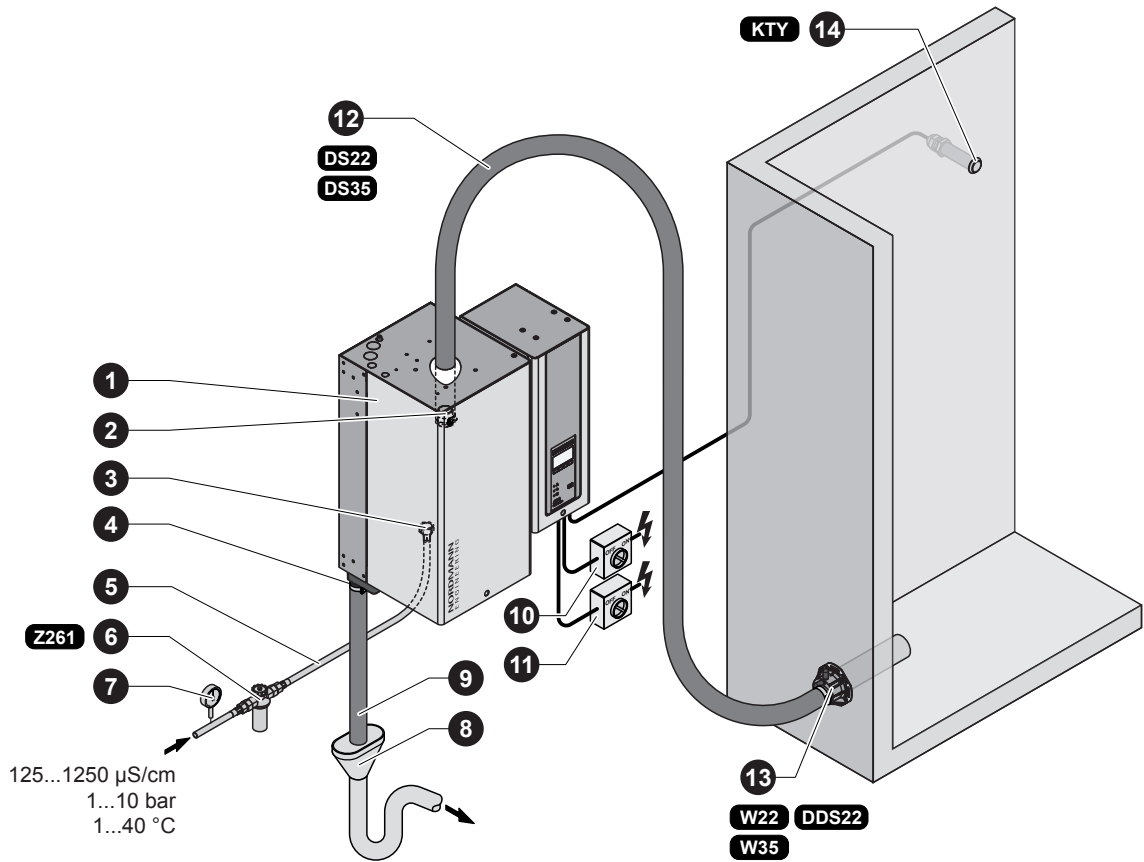

125...1250 $\mu\text{S}/\text{cm}$
 1...10 bar
 1...40 °C

- | | |
|---------------------------------------------------------------------------------------------------------------------------------------------------------------------------------------------------------------------------------------------------------------------------------------------------------------------------------------------|----------------------------------------------------------------------------------------------------------------------------------------------------------------------------------------------------------------------------------------------------------------------------------------------------------------------------------------------------------------------------------------------------------------------------------------------------------------------------------------|
| <ul style="list-style-type: none"> 1 Steam generator 2 Steam connector 3 Water drain connector 4 Water supply connector 5 Water connection hose G 3/4"- G 3/8"
(included in the delivery) 6 Filter valve (accessory "Z261") 7 Manometer (installation recommended) | <ul style="list-style-type: none"> 8 Funnel with siphon (building side) 9 Water drain hose (included in the delivery) 10 Service switch heating voltage supply (building side) 11 Service switch control voltage supply (building side) 12 Steam hose (accessory "DS22"/"DS35") 13 Steam distributor (accessory "W.." / "DDS22") 14 Temperature sensor (accessory "KTY") or humidity sensor (caldarium operation) |
|---------------------------------------------------------------------------------------------------------------------------------------------------------------------------------------------------------------------------------------------------------------------------------------------------------------------------------------------|----------------------------------------------------------------------------------------------------------------------------------------------------------------------------------------------------------------------------------------------------------------------------------------------------------------------------------------------------------------------------------------------------------------------------------------------------------------------------------------|

4 Operation

4.1 Commissioning

Proceed as follows when putting the steam generator into operation:

1. **Examine the steam generator and installation for possible damage.**



DANGER!

Damaged devices or devices with damaged installation may present danger to human life or cause severe damage to material assets.

Damaged units and/or units with damaged or faulty installation must not be operated.

2. Check whether the front panels are mounted and correctly fixed.
3. Open the **filter valve** (or the shut-off valve, respectively) in the water supply line.
4. **Switch on the service switches** for mains supplies (heating and control voltage).
5. **Actuate the unit switch** of the steam generator. Switch lights up.

The steam generator carries out a **system test**, during which all three LED's light up.

If a failure occurs on the system test, a corresponding error message is shown in the display.

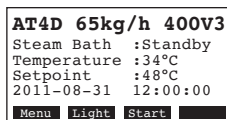
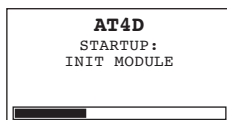

After the system test the unit is in **normal operation mode**. The display shows the **standard operating display** (first page of the indication level). Note: The contents of the standard operating display depends on the actual operating status and on the configuration of the Nordmann AT4 D and can differ from the opposite display.

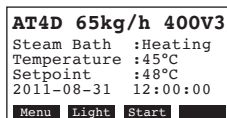

Depending on the selected operating mode of the Nordmann AT4 D, the steam generator must manually be started via the Start/Stop button of the display and control unit or via an external Start/Stop button or the operation runs time-controlled via the day timer or the week timer. As soon as the steam generator is started, the heating current is switched on. The inlet valve opens (slight delay) and the steam cylinder fills with water. As soon as the submerged electrodes heat the water up the green LED lights up and after a few minutes (approx. 5–10 minutes, depending on the conductivity of the water) steam is produced.

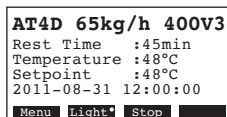

As soon as the set temperature (steam bath operation) or the set humidity (caldarium operation) in the steam bath cabin is achieved, the light is switched on and the bath phase starts. During the bath phase the fragrance pump (if available) is controlled in accordance with the selected operating mode and the fan (or the flap actuator) is controlled in accordance with the set temperature or humidity and the actual temperature or the actual humidity in the steam bath cabin.

Note: If the Nordmann AT4 D is operated with water of low conductivity it may happen that the maximum steam capacity is not reached in the first few hours of operation. This is normal. As soon as the conductivity has reached a sufficient level (due to the vaporisation process) the steam generator will reach the maximum steam capacity.

4.2 Notes on operation

4.2.1 Function of the display and operating elements

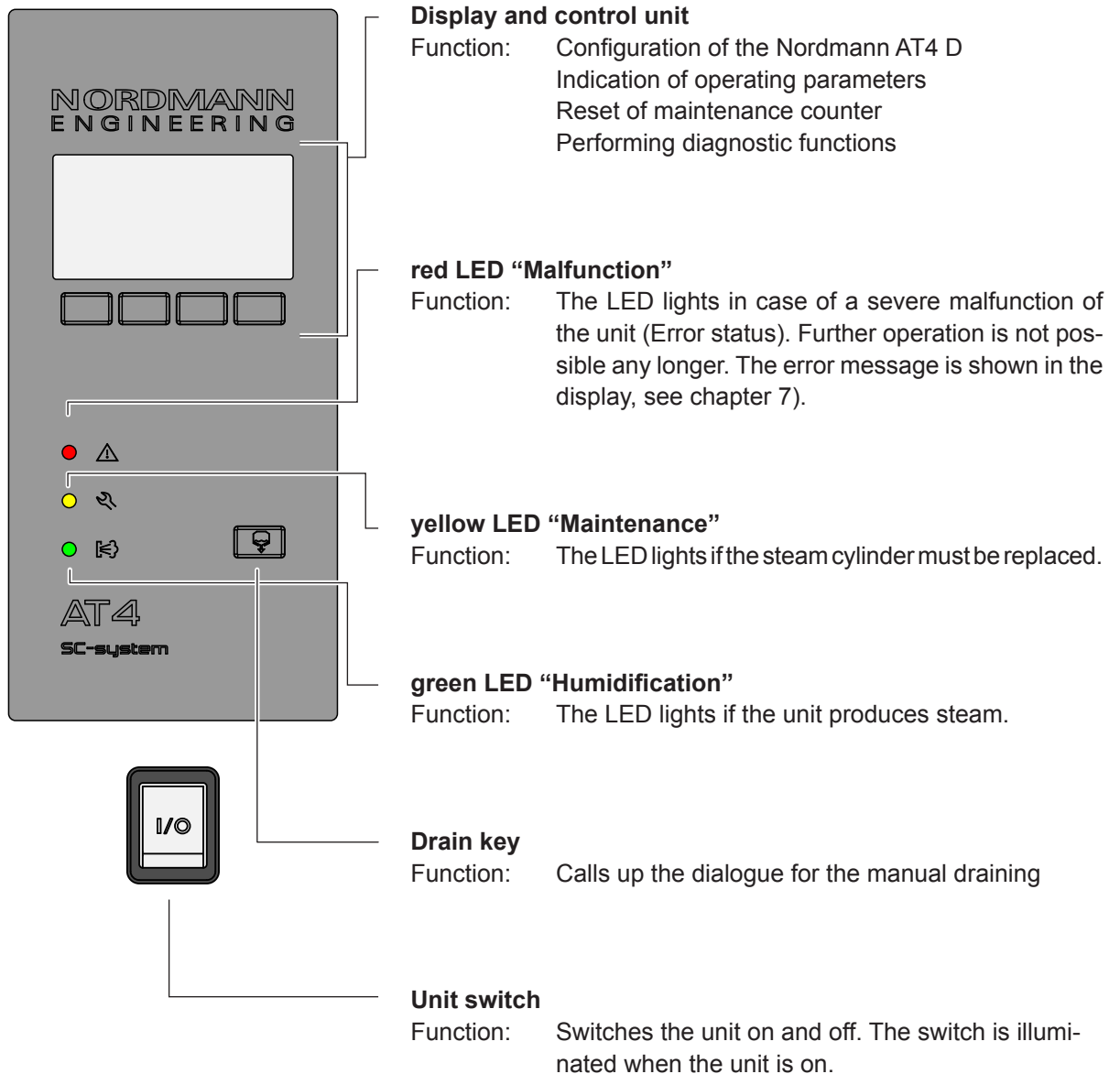

4.2.2 Remote operating and fault indication

Via the operating and fault indication the following operating status are shown remotely:

Activated remote indication relay	When?	Display on unit
"Error"	A error is present, further operation is normally not possible any longer, the heating voltage is interrupted.	Red LED lights and an error message is shown in the display.
"Service"	The steam cylinder is spent and must be replaced. The unit remains operational for a certain time.	Yellow LED lights and the service message is shown in the display.
"Steam"	Steam demand/Steam production	Green LED lights and the standard operating display is shown.
"Unit on"	Unit is switched on.	Unit switch lights and the standard operating display is shown.

4.2.3 Notes on the operation at ambient temperatures $\leq 0^{\circ}\text{C}$

If during operation ambient temperatures $\leq 0^{\circ}\text{C}$ must be expected (operation of the Nordmann AT4 D in a protective housing outside the building), the standby draining function must be set to "Full" and the period of time in standby operation after which an automatic cylinder draining takes place must be set to 1 hour (see chapter 5.3.7.3).

4.2.4 Inspections during operation

During operation the Nordmann AT4 D and the humidification system have to be inspected weekly. On this occasion check the following:

- the water and steam installation for any leakage.
- the steam generator and the other system components for correct fixing and any damage.
- the electric installation for any damage.

If the inspection reveals any irregularities (e.g. leakage, error indication) or any damaged components take the Nordmann AT4 D out of operation as described in chapter 4.4. Then, contact your Nordmann representative.

4.3 Carrying out manual draining

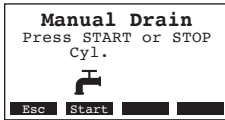

Proceed as follows to drain the unit manually:

1. **Briefly press the drain key.** The draining dialogue appears in the display.
Note: With double units both cylinders can be drained separately in the draining dialogue.
2. Press the **<Start>** key. The heating voltage is interrupted and the drain pump starts. The **yellow LED flashes.**
To stop the drain cycle briefly press the **<Stop>** key.

Note: by pressing the **<Esc>** key the display unit returns to the indication level. A draining cycle in progress is interrupted automatically.

4.4 Taking the unit out of operation

In order to take the steam generator out of operation, perform the following steps:

1. If the unit has to be switched off because of a malfunction, please note the error code (number of flashes of the red and yellow LED) of the actual error message shown in the display.
2. If possible, wait until the drying process of the steam bath cabin is finished.
3. Close the shut-off valve in the water supply line.
4. Start manual draining (see chapter 4.3) and wait until the steam cylinder is empty.
Note: If the drain pump is defective, the steam cylinder is to be emptied manually via the manual draining hose.
5. **Actuate the unit switch.**
6. **Disconnect steam generator from the mains:** Switch off all service switches to mains supplies (heating and control voltage) and secure switches in "off" position against accidentally being switched on, and clearly mark the switches.
7. If **ambient temperatures $\leq 0^{\circ}\text{C}$** must be expected when the unit is out of operation (operation of the Nordmann AT4 D in a protective housing outside the building): drain the water supply pipe and the water filter (filter valve).



WARNING!
Danger of burning!

If steam was produced just before the unit is taken out of operation, wait before opening the unit and let the steam cylinder cool down to prevent danger of burning.

5 Working with the unit control

Note: if you are working with the optional **remote terminal** read **chapter 5.6 “Working with the remote terminal” first**. The operation of the remote terminal deviates in some points from the operation at the steam generator and some adjustments are blocked via the remote terminal for safety reasons.

5.1 Operating the control unit and menu overview

```
AT4D 65kg/h 400V3
Steam Bath :Standby
Temperature :34°C
Setpoint   :48°C
2011-08-31 12:00:00
Menu Light Start
```



Operating

The operating and display unit is operated via the four keys located just below the display. The 4 status fields at the bottom of the display show the active keys the functions assigned to them.

actual key setting

keys

Menu overview

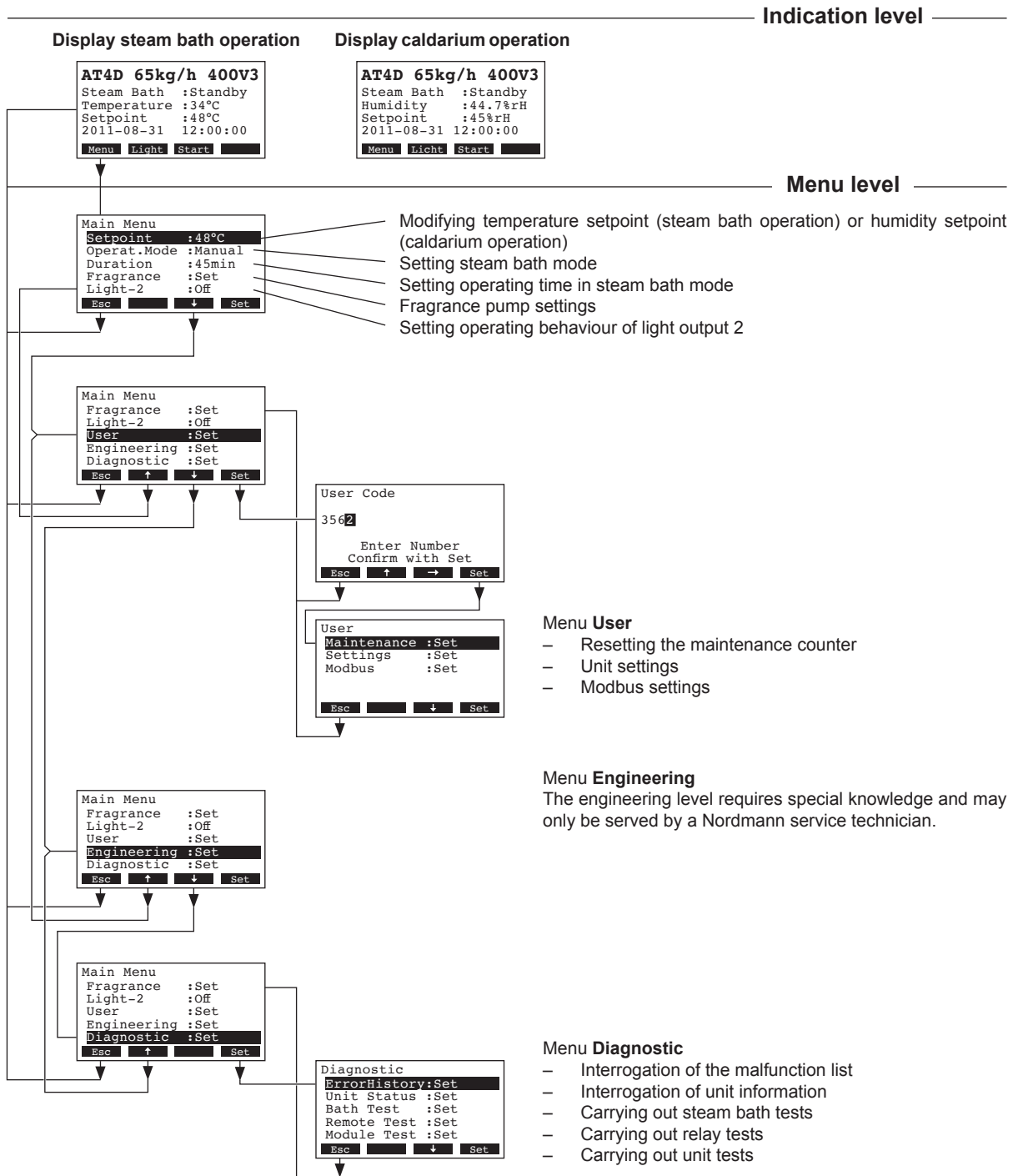

5.2 Basic steam bath settings

5.2.1 Setting the temperature setpoint (steam bath operation) or humidity setpoint (caldarium operation)

Select “Setpoint” in the main menu, then press the <Set> key.

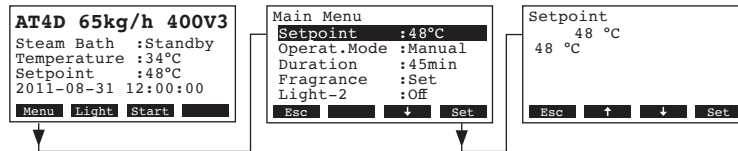

In the upcoming modification dialogue set the desired temperature or humidity setpoint.

Factory setting: **48 °C (45 %rH)**

Setting range: **25 ... 55 °C (30...90 %rH)**

5.2.2 Setting the control mode

Note: this menu item is available only if the operating mode in the steam bath control settings (see chapter 5.3.3.1) is set to “Panel”.

Select “Operat.Mode” in the main menu, then press the <Set> key.

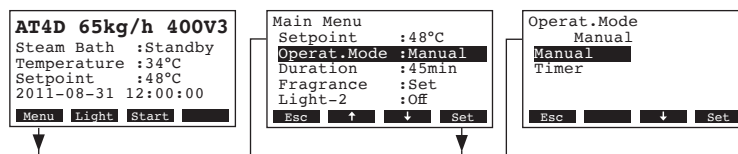

In the upcoming modification dialogue select the desired control mode for panel operation.

Factory setting: **Manual**

Options: **Manual, Timer**

Description of the control mode settings

- **Manual:** The steam generator must be switched on and off via the Start/Stop key of the display and control unit or via an external Start/Stop key.
- **Timer:** The steam generator is switched on and off time controlled via the day timer.
The timer settings can be accessed by pressing the <Timer> key in the standard operating display.

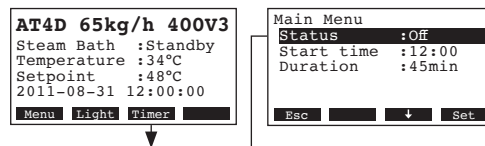

- **Status:** activate (On) or deactivate (Off) timer function
Note: the day timer must be activated every time after the steam bath time has elapsed.
- **Start time:** set starting time (format: hh:mm)
- **Duration:** set heating time in minutes

5.2.3 Setting the steam bath time

Note: this menu item is available only if the operating mode in the steam bath control settings (see chapter 5.3.3.1) is set to "Panel" and the control mode is set to "Manual" (see chapter 5.2.2).

Select "Duration" in the main menu, then press the <Set> key.

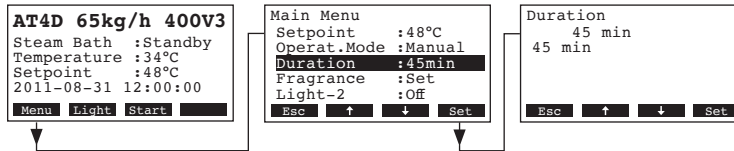

In the upcoming modification dialogue set the desired steam bath time.

Factory setting: **45 minutes**
Setting range: **1 ... 1080 minutes**

5.2.4 Configuring the fragrance pump(s)

Select "Fragrance" in the main menu, then press the <Set> key. In the upcoming display, select the desired fragrance pump whose settings you want to modify, then press the <Set> key.

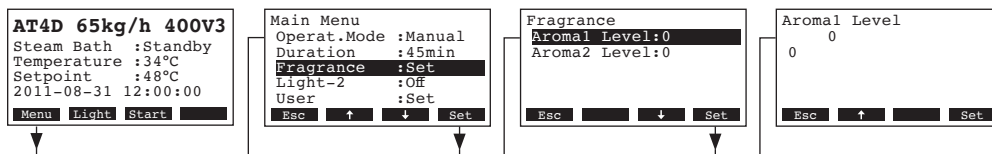

In the upcoming modification dialogue set the desired intensity level (1-5 or 0: fragrance pump deactivated) for the selected fragrance pump.

Factory setting: **0**
Setting range: **0: fragrance pump deactivated**
1: interval time: 10 minutes, pulse duration: 2 seconds
2: interval time: 8 minutes, pulse duration: 3 seconds
3: interval time: 6 minutes, pulse duration: 3 seconds
4: interval time: 4 minutes, pulse duration: 4 seconds
5: interval time: 3 minutes, pulse duration: 5 seconds

Note: the fragrance pump is active only, if the main contactor of the steam generator is activated and the system is in steam bath operation.

Note: the interval time and the pulse duration of the fragrance injection can be set individually in the engineering level. If necessary, please contact your Nordmann service technician.

5.2.5 Switching the effect light (Light-2) on and off

Select “Light-2” in the main menu, then press the <Set> key.

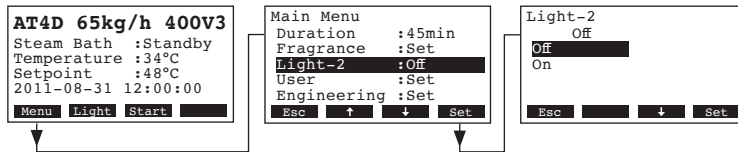

In the upcoming modification dialogue you can switch on and off the effect light (Light-2).

Factory setting: **Off**

Setting range: **Off** (effect light switched off)
On (effect light switched on)

5.3 Unit settings in the user settings menu

5.3.1 Launching the user settings menu

Select the user settings menu:

Path: **Main Menu > User > Password entry: 3562 > Settings**

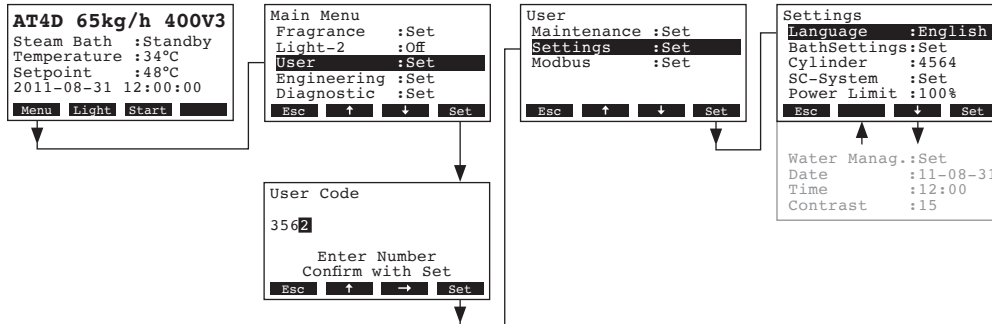

The setting parameters appear. Press the <↓> and <↑> keys in order to select the individual settings or settings submenus. Detailed information on the different settings are found in the following chapters.

5.3.2 Selecting the dialogue language

Select "Language" in the unit settings menu, then press the <Set> key.

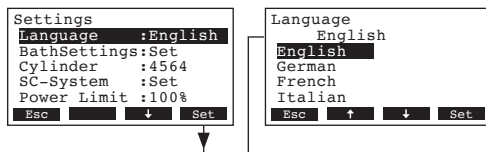

In the upcoming modification dialogue select the desired dialogue language. After confirmation, the unit automatically switches to the selected dialogue language.

Factory setting: **country specific**

Options: **diverse languages**

5.3.3 Steam bath control settings

Select "BathSettings" in the unit settings menu, then press the <Set> key.

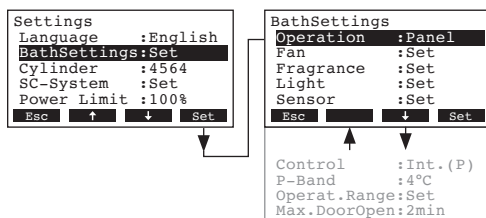

The setting parameter for the steam bath control appear. Press the <↓> and <↑> keys in order to select the individual settings or settings submenus. Detailed information on the different settings are found in the following chapters.

5.3.3.1 Setting the operation mode

Select **“Operation”** in the steam bath settings menu, then press the **<Set>** key.

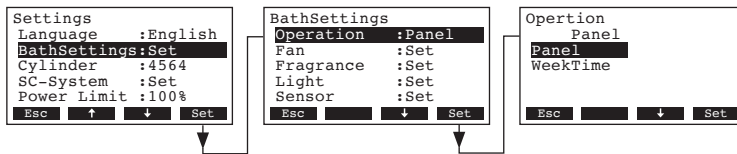

In the upcoming modification dialogue you determine, whether the bathing operation shall be started manually or via the day timer function (Panel) or automatically via the week timer function (WeekTime).

Factory setting: **Panel**

Options: **Panel** (manually or day timer controlled)
WeekTime (week timer controlled)

5.3.3.2 Configuring week timer

Note: this menu item is available only if the operating mode (see chapter 5.3.3.1) is set to “WeekTime”.

- Deactivating the Week Timer :

Select **“Week Timer”** in the steam bath settings menu, then press the **<Set>** key.

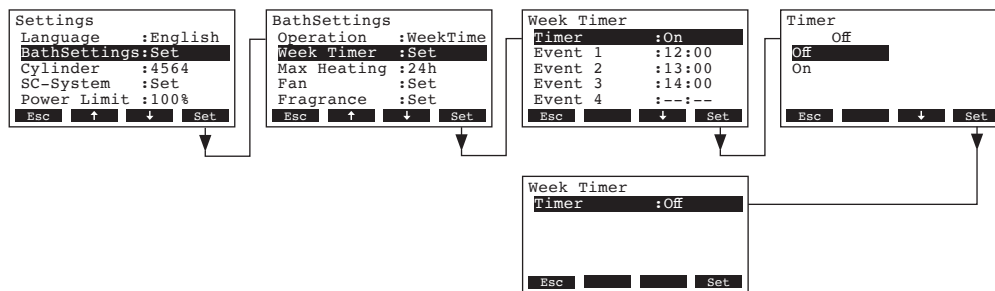

Select **“Timer”**, then press the **<Set>** key. In the upcoming modification dialogue deactivate (off) the timer function and confirm the setting with the **<Set>** key.

If the timer functions is deactivated the Nordmann AT4 remains in standby operation until the timer is activated again or the operating mode is changed to “Panel” (see chapter 5.3.3.1).

- Activating and configuring the Week Timer :

Select **“Week Timer”** in the steam bath settings menu, then press the **<Set>** key.

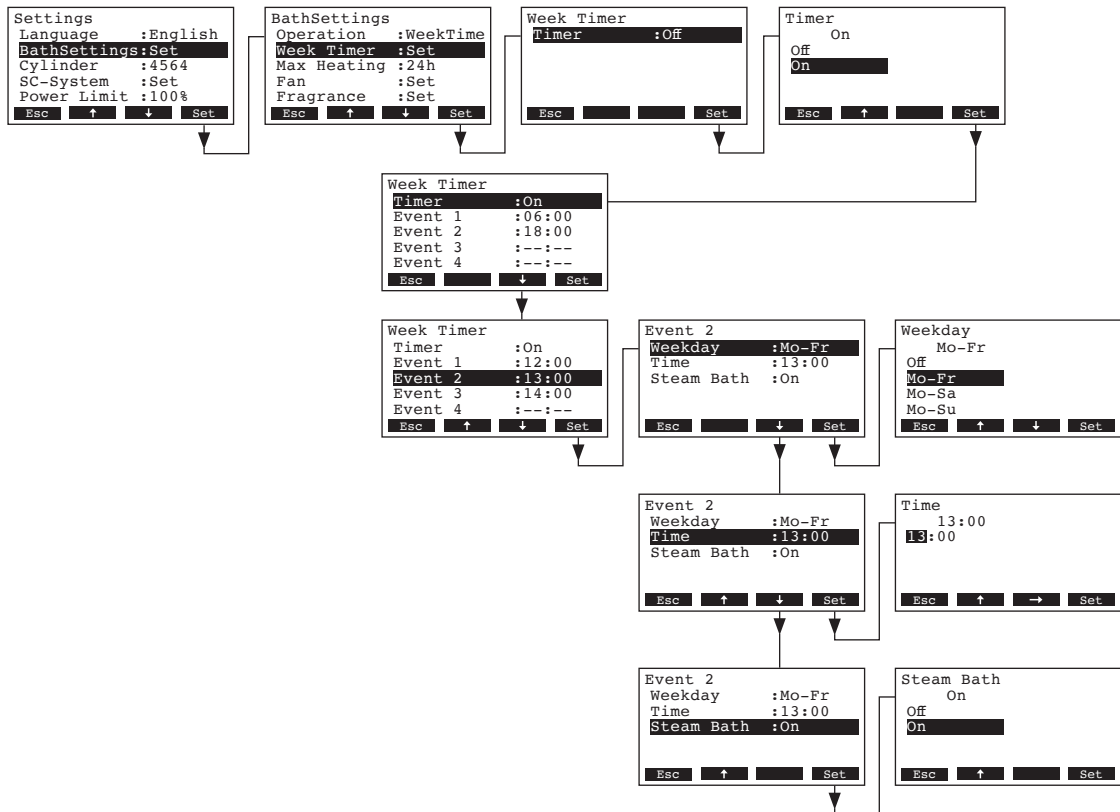

Select **“Timer”**, then press the **<Set>** key. In the upcoming modification dialogue activate (On) the timer function and confirm the setting with the **<Set>** key.

If the timer is activated, up to eight switching points (events 1 - 8) with different operating status of the steam generator can be defined. Each switching point is defined by a weekday or weekday range, the switching point and the operating status of the steam generator.

Configuration notes:

- the settings of an event remain active up to the next event.
- the software does not check the plausibility of the timer settings. Therefore, make sure your settings make sense.

5.3.3.3 Setting the maximum heating time for week timer operation

Note: this menu item is available only if the operating mode (see chapter 5.3.3.1) is set to “WeekTime”.

Select **“Max.Heating”** in the steam bath settings menu, then press the **<Set>** key.

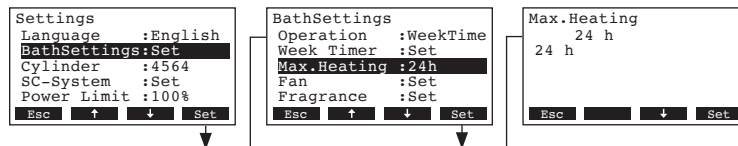

In the upcoming modification dialogue set the maximum heating time in hours.

Factory setting: **1 hours**

Setting range: **1 ... 24 hours**

5.3.3.4 Fan control settings

– Operation without fan

Select “Fan” in the steam bath settings menu, then press the <Set> key. In the following display select “Mode”, then press the <Set> key.

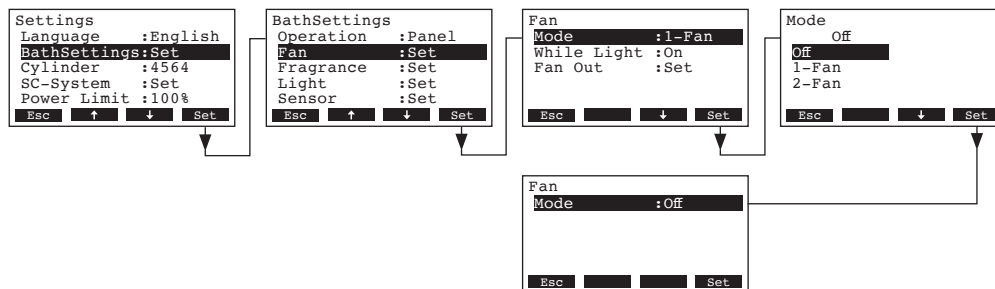

Adjust the settings for the operation without fan as follows:

- “Mode”: Off

Note: use this setting if no fan is connected to the Nordmann AT4 D (e.g. for steam baths with flap actuators). In the bathing operation without fan the drying phase is omitted.

– Operation with 3-step exhaust air fan

Select “Fan” in the steam bath settings menu, then press the <Set> key. In the following display select “Mode”, then press the <Set> key.

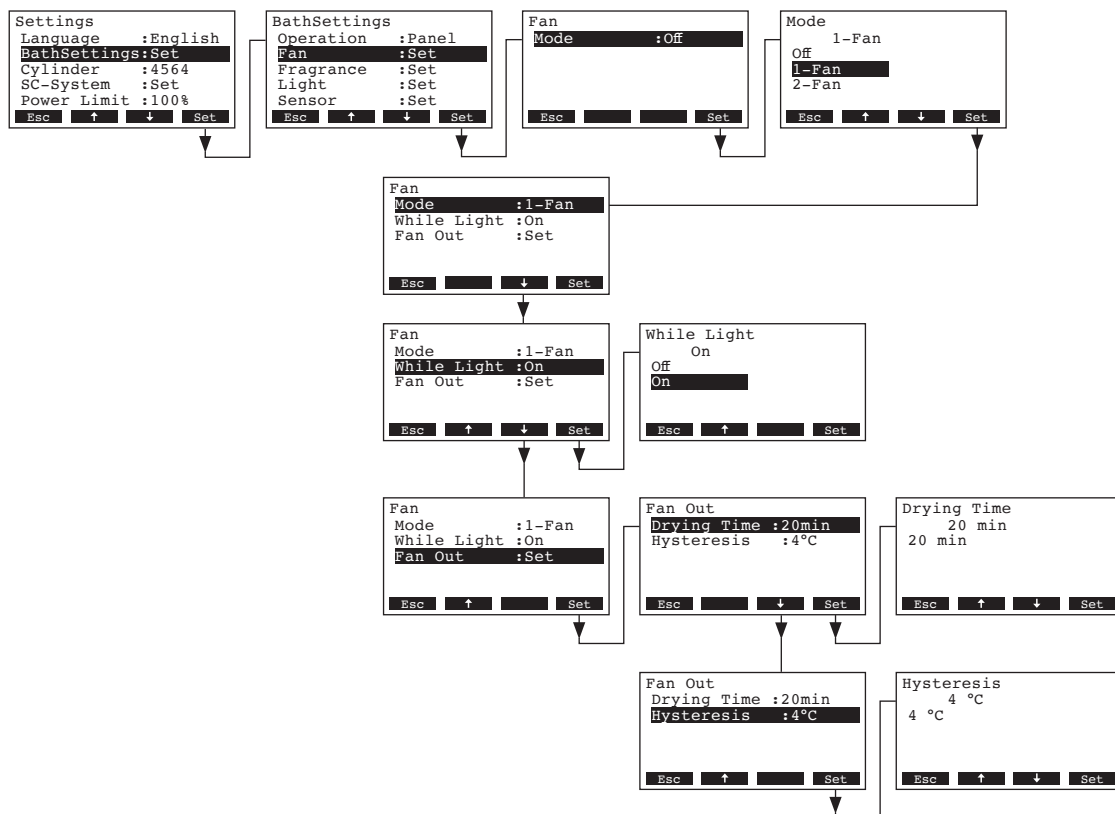

Adjust the settings for the operation with a 3-step exhaust air fan as follows:

- “Mode”: 1-Fan
- “While Light”: If this function is activated (On, factory setting) the 3-step exhaust air fan starts running on step 1, as soon as light 1 or light 2 is switched on in standby mode. The fan stops if the light is switched off again.

- **“Fan Out”**: Settings for the control of the exhaust fan.
- **“Drying Time”**: Time in minutes the exhaust fan continues to run after the steam bath time has elapsed to dry the steam bath cabin (Factory setting: 20 minutes, Setting range: 1...60 minutes).
- **“Hysteresis”**: Hysteresis value in °C (steam bath operation) or %rh (caldarium operation) to switch on and off the exhaust fan (Factory setting: 4 °C/18 %rh, Setting range: 2...60 °C/6...65 %rh).

Note: in steam bath operation the exhaust fan switches off if the temperature or the humidity in the steam bath cabin drops half of the selected hysteresis value below the set setpoint value, and switches on if the temperature or the humidity in the steam bath cabin increases half of the selected hysteresis above the set setpoint value.

– Operation with supply and exhaust fan

In this operation mode a supply and an exhaust fan is connected to the Nordmann AT4 D.

Select “Fan” in the steam bath settings menu, then press the <Set> key. In the following display select “Mode”, then press the <Set> key.

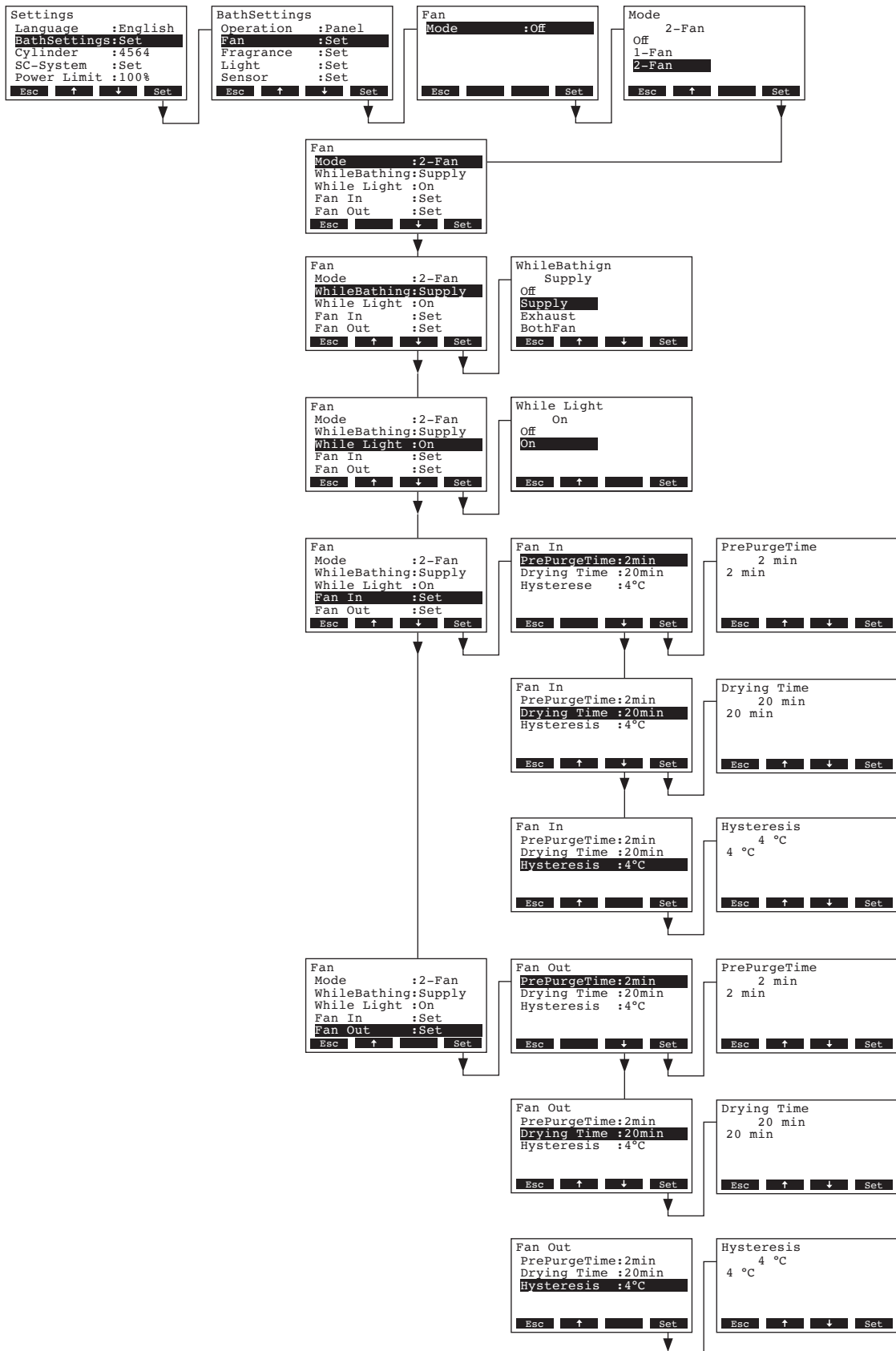

Adjust the settings for the operation with a supply and an exhaust fan as follows:

- **“Mode”:** **2-Fan**
- **“WhileBathing”:** Activation mode of the fans in bathing operation
 - “Off”** (both fans remain switched off during bathing operation)
 - “Supply”** (only the supply air fan is running during bathing operation)
 - “Exhaust”** (only the exhaust air fan is running during bathing operation)
 - “BothFan”** (both fans are running during bathing operation)
 - “Automat.”** (during bathing operation both fans are controlled automatically dependent on the temperature or the humidity in the steam bath cabin)
- **“While Light”:** If this function is activated (On, factory setting) the exhaust fan starts running, as soon as light 1 or light 2 is switched on in standby mode. The fan stops if the light is switched off again.
- **“Fan In”:** Settings for the control of the supply fan.

Note: If the supply fan is controlled with the **“RLS” option** dependent on the heating voltage (supply fan is running, when the heating voltage contactor is switched on) **all software settings of the supply fan are without function.**

- **“PrePurgeTime”:** Time in minutes in the heating phase during which the supply fan is switched on (Factory setting: 2 minutes, Setting range: 0..60 minutes).
- **“Drying Time”:** Time in minutes the supply fan continues to run after the steam bath time has elapsed to dry the steam bath cabin (Factory setting: 20 minutes, Setting range: 1..60 minutes).
- **“Hysteresis”:** Hysteresis value in °C (steam bath operation) or %rh (caldarium operation) to switch on and off the supply fan (Factory setting: 4 °C/18 %rh, Setting range: 2..60 °C/6..65 %rh).

Note: in steam bath operation the supply fan switches off if the temperature or the humidity in the steam bath cabin drops half of the selected hysteresis value below the set setpoint value, and switches on if the temperature or the humidity in the steam bath cabin increases half of the selected hysteresis above the set setpoint value.
- **“Fan Out”:** Settings for the control of the exhaust fan.
 - **“PrePurgeTime”:** Time in minutes in the heating phase during which the exhaust fan is switched on (Factory setting: 2 minutes, Setting range: 0..60 minutes).
 - **“Drying Time”:** Time in minutes the exhaust fan continues to run after the steam bath time has elapsed to dry the steam bath cabin (Factory setting: 20 minutes, Setting range: 1..60 minutes).
 - **“Hysteresis”:** Hysteresis value in °C (steam bath operation) or %rh (caldarium operation) to switch on and off the exhaust fan (Factory setting: 4 °C/18 %rh, Setting range: 2..60 °C/6..65 %rh).

Note: in steam bath operation the exhaust fan switches off if the temperature or the humidity in the steam bath cabin drops half of the selected hysteresis value below the set setpoint value, and switches on if the temperature or the humidity in the steam bath cabin increases half of the selected hysteresis above the set setpoint value.

5.3.3.5 Fragrance pump control settings

At the Nordmann AT4 D control two fragrance pumps can be connected, which can be activated either via the integrated interval control or via an external push-button.

Select **"Fragrance"** in the steam bath settings menu, then press the **<Set>** key. In the upcoming display, select the desired fragrance pump whose operating mode you want to modify, then press the **<Set>** key.

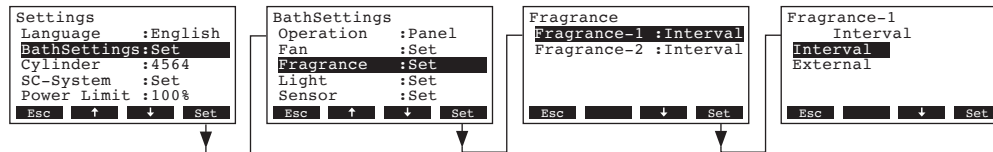

In the upcoming modification dialogue select the desired operating mode for the selected fragrance pump.

Factory setting: **Interval**

Options: **Interval** (fragrance pump is activated via the integrated interval)

External (fragrance pump must be activated manually via an external push-button)

Note: the fragrance pump is active only, if the main contactor of the steam generator is activated and the system is in steam bath operation.

5.3.3.6 Light control settings

At the Nordmann AT4 D control a cabin light (Light-1) or effect light (Light-2) can be connected. Both lights can be switched on independently either manually automatically.

Select **"Light"** in the steam bath settings menu, then press the **<Set>** key. In the upcoming display, select the desired light whose operating mode you want to modify, then press the **<Set>** key.

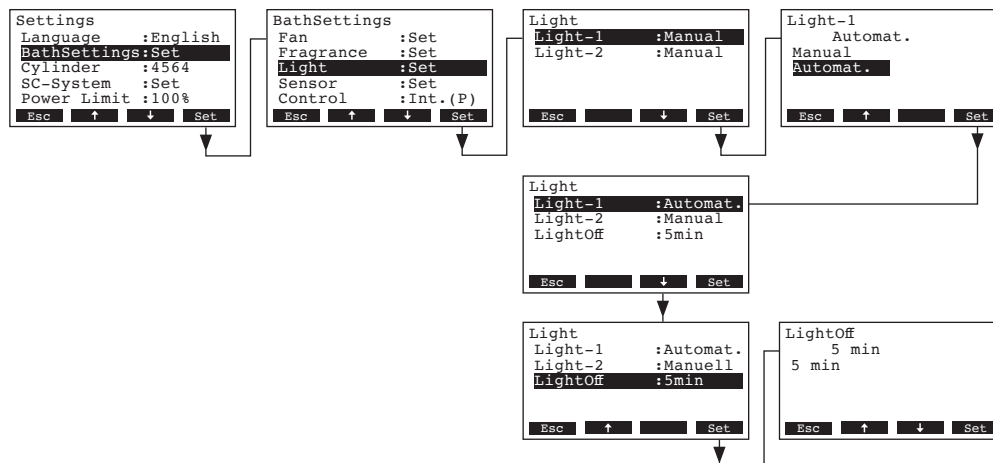

In the upcoming modification dialogue select the desired operating mode for the selected light.

Factory setting: **Manual**

Options: **Manual** (manual activation of light 1 and light 2 via light switches)

Automat. (automatic activation of light 1 and light 2 as soon as the set steam bath temperature (steam bath operation) or the set humidity (caldarium operation) is reached in the steam bath cabin)

Note: if automatic activation of light is selected the menu item **"LightOff"** appears additionally. With this setting you can determine how long the light remains switched on after the steam bath time has ended (Factory setting: 5 minutes, Setting range: 1... 600 minutes).

5.3.3.7 Sensor signal settings

With the parameters in the submenu “Sensor” you can configure the sensor signal settings.

- Temperature signal input from **analogue temperature sensor** (KTY, PT100, PT-1000) connected to the steam bath print.

Select “**Sensor**” in the steam bath settings menu, then press the <Set> key.



Adjust the parameters in the submenu “Sensor” as follows:

- “**SignalSource**”: “**Analog**”
- “**Mode**”: “**Temp.**”
- “**Type**”: “**KTY**”, “**PT-100**” or “**PT-1000**”
- “**Offset**”: Temperature offset of the selected temperature sensor to the temperature value measured with a proofed measuring instrument in the steam bath cabin (Factory setting: 0.0 °C, Setting range: –5 °C...5 °C)

- **Linearised 0-10V temperature signal** from a temperature sensor or a building management system connected to the control signal input on the power board of the Nordmann AT4 D.

Select **"Sensor"** in the steam bath settings menu, then press the **<Set>** key.

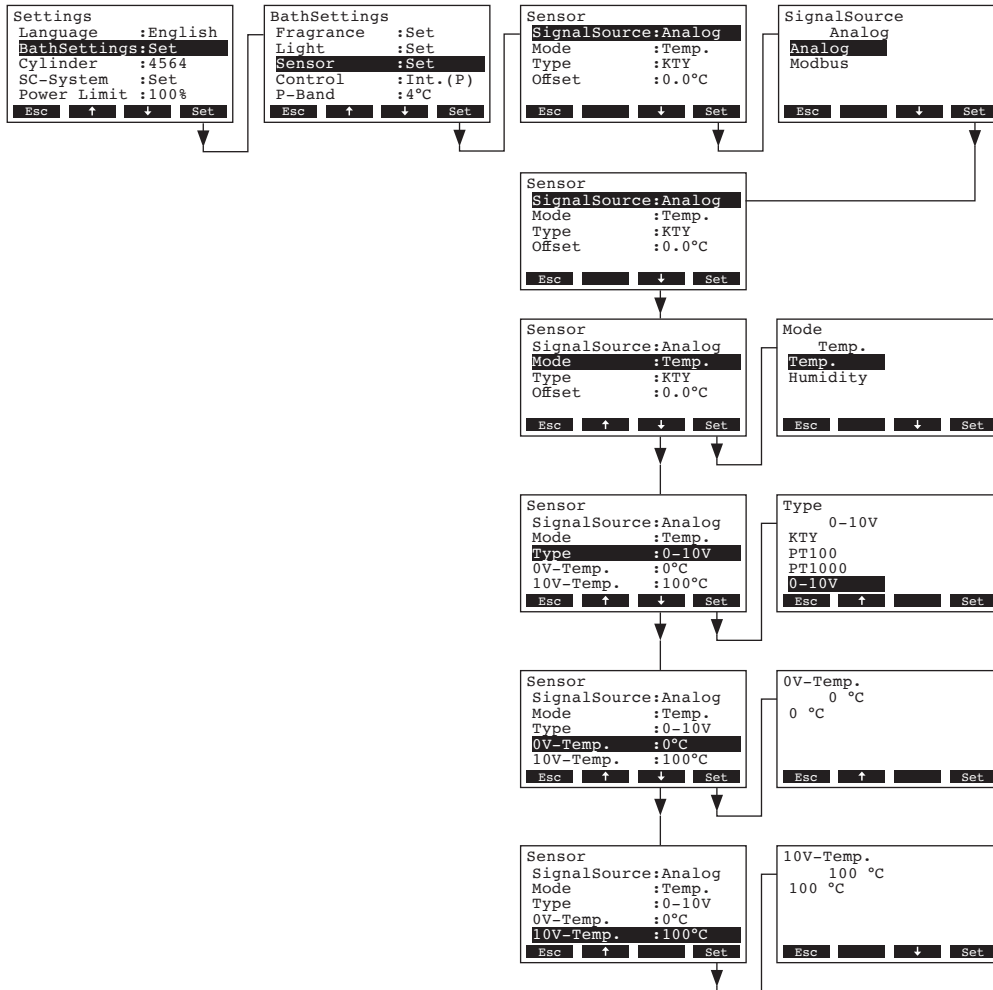

Adjust the parameters in the submenu "Sensor" as follows:

- **"SignalSource":** **"Analog"**
- **"Mode":** **"Temp."**
- **"Type":** **"0-10V"**
- **"0V-Temp.":** 0V temperature value in °C of the connected 0-10V temperature sensor (Factory setting: 0 °C, Setting range: -50...+20 °C)
- **"10V-Temp.":** 10V temperature value in °C of the connected 0-10V temperature sensor (Factory setting: 100°C, Setting range: +80...+200 °C)

- Humidity signal input from **analogue humidity sensor** connected to the signal input on the power board of the steam generator (caldarium operation).

Select “**Sensor**” in the steam bath settings menu, then press the <Set> key.



Adjust the parameters in the submenu “Sensor” as follows:

- “**SignalSource**”: “**Analog**”
- “**Mode**”: “**Humidity**”
- “**Type**”: Sensor signal type (Factory setting: 0–10V, Options: 0–5V, 1–5V, 0–10V, 2–10V, 0–16V, 3.2–16V, 0–20mA, 4–20mA)

– **Control signal (temperature or humidity signal) input via Modbus**

Select “**Sensor**” in the steam bath settings menu, then press the <Set> key.



Adjust the parameters in the submenu “Sensor” as follows:

- “**SignalSource**”: “**Modbus**”
- “**Timeout**”: Timeout in seconds for signal transmission (Factory setting: 5 seconds, Setting range: 1...600 seconds)
- “**Mode**”: **Temp.** (control via a temperature signal for steam bath operation) or **Humidity** (control via a humidity signal for caldarium operation)

5.3.3.8 Setting the controller type

Select “Control” in the steam bath settings menu, then press the <Set>.

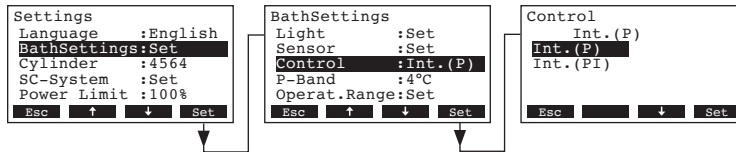

In the upcoming modification dialogue select the desired controller type.

Factory setting: **Int (P)**

Options: **Int (P) or Int (PI)**

5.3.3.9 Setting the proportional range for the internal P/PI controller

Select “P-Band” in the steam bath settings menu, then press the <Set>.

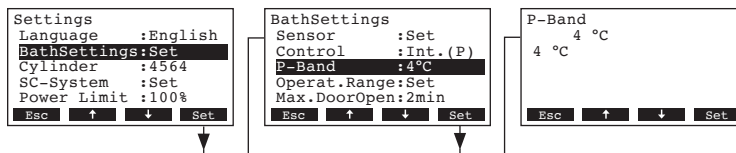

In the upcoming modification dialogue set the proportional range in °C or %rH (caldarium operation) for the internal P/PI controller.

Factory setting: **4 °C (18 %rH)**

Options: **2...60 °C (6...65 %rH)**

5.3.3.10 Setting the integral time for the internal PI controller

Note: this setting is available only if the internal PI controller is activated.

Select “Integr.-Time” in the steam bath settings menu, then press the <Set> key.

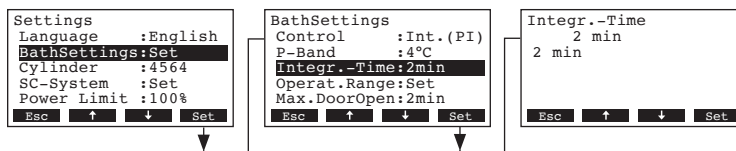

In the upcoming modification dialogue set the integral time in minutes for the internal PI controller.

Factory setting: **2 minutes**

Options: **1...60 minutes**

5.3.3.11 Configuring the Quasi On/Off control

With the parameters in the submenu “Operat.Range” you can control the operation of Nordmann AT4 D in such a way that the steam production is started only from a certain request and stopped again, if the request has dropped by a certain percentage.

Select “Operat.Range” in the steam bath settings menu, then press the <Set> key.



Adjust the parameters in the submenu “Operat.Range” for the quasi On/Off control to the desired values:

- **“Mode”:** Activating/Deactivating the quasi On/Off control function (Factory setting: Off)
- **“OnThreshold”:** Demand in % of the maximum steam capacity at which the steam production is to be started (Factory setting: 60 %, Setting range: 30...90 %)
- **“Hysteresis”:** Percentage, the request must drop, until the steam operation is stopped (Factory setting: 5 %, Setting range: 1...20%)

5.3.3.12 Setting the maximum door opening time

Select “Max.DoorOpen” in the steam bath settings menu, then press the <Set> key.

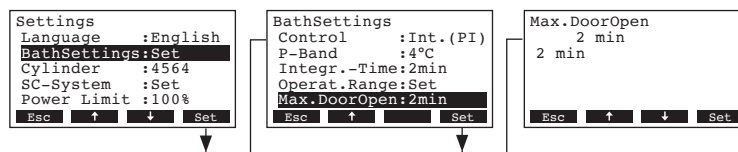

In the upcoming modification dialogue set the maximum time in minutes the steam bath door may be open, until the bathing operation is stopped.

- Factory setting: **2 minutes**
 Options: **1...30 minutes**

5.3.4 Selecting the cylinder type

Note: this function is **not available** via the optional remote terminal.

Select “**Cylinder**” in the user settings menu, then press the **<Set>** key.

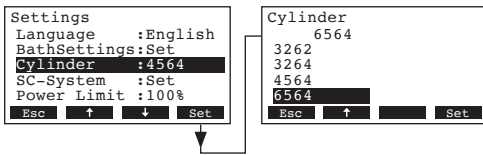

In the upcoming modification dialogue select the steam cylinder type installed in the unit (see type plate on the steam cylinder).

Factory setting: **according to the installed cylinder**

Options: **522, 524, 532, 534, 822, 824, 832, 834, 1532, 1534, 2362, 2364, 3262, 3264, 4564, 6564**

5.3.5 Configuring the SC system

Select “**SC-System**” in the user settings menu, then press the **<Set>** key.

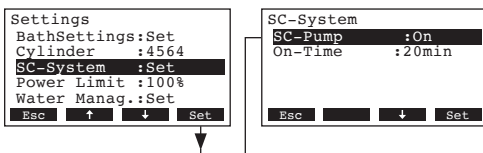

The settings parameter for the lime management system appear. Detailed information on the different settings are found in the following chapters.

5.3.5.1 Activating/deactivating the SC system

Select “**SC-Pump**” in the SC system settings menu, then press the **<Set>** key.

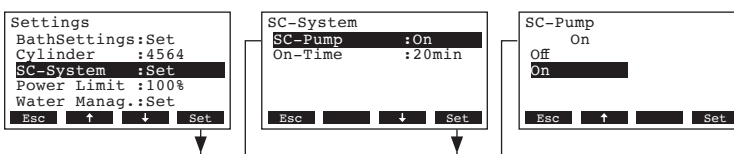

In the upcoming modification dialogue activate or deactivate the SC system.

Factory setting: **On**

Options: **On, Off**

5.3.5.2 Setting the operation time of the SC-Pump

Select “On-Time” in the SC-System settings menu, then press the <Set> key.

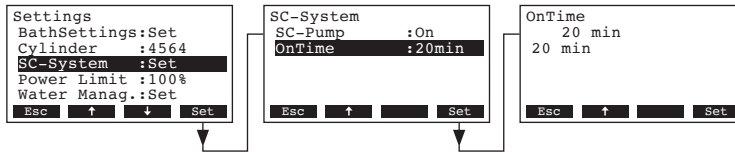

In the upcoming modification dialogue set the operating time of the SC-Pump per hour in minutes.

Factory setting: **20 minutes**

Setting range: **20 ... 60 minutes**

5.3.6 Configuring the capacity limitation

Select “Power Limit” in the user settings menu, then press the <Set> key.

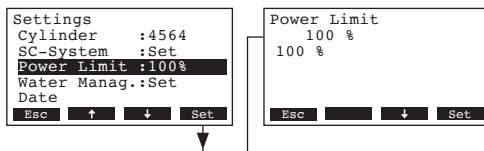

In the upcoming modification set the desired capacity limitation in % of maximum steam capacity.

Factory setting: **100 %**

Setting range: **30 ... 100 %**

5.3.7 Water management settings

Select “Water Manag.” in the user settings menu, then press the <Set> key.

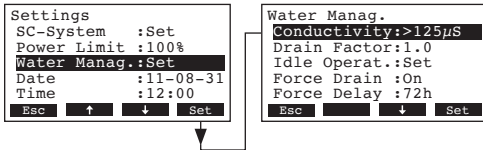

The water management settings appear. Press the <↓> and <↑> keys in order to select the individual settings. Detailed information on the different settings are found in the following chapters.

5.3.7.1 Selecting the conductivity range of the supply water

Select “Conductivity” in the water management settings submenu, then press the <Set> key.

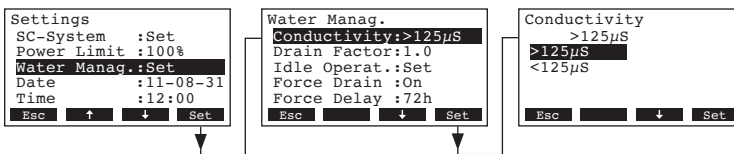

In the upcoming modification dialogue select the conductivity range of the supply water.

Factory setting: >125 µS/cm

Options: >125 µS/cm, <125 µS/cm

5.3.7.2 Setting the drain factor

Select “Drain Factor” in the water management settings submenu, then press the <Set> key.

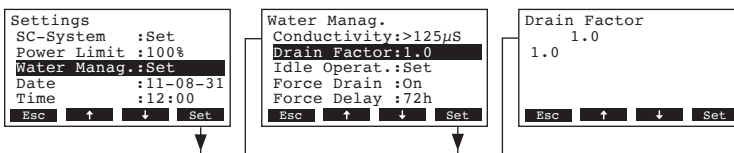

In the upcoming modification dialogue set the drain factor in relation to the steam capacity.

Factory setting: 1.0

Setting range: 0.5...2.0

5.3.7.3 Setting the operating mode for standby operation

– Idle only operation

In this operating mode the cylinder is not emptied in standby operation.

Select “Idle Operat.” in the water management settings submenu, then press the <Set> key. In the upcoming submenu select “Idle Mode”, then press the <Set> key.

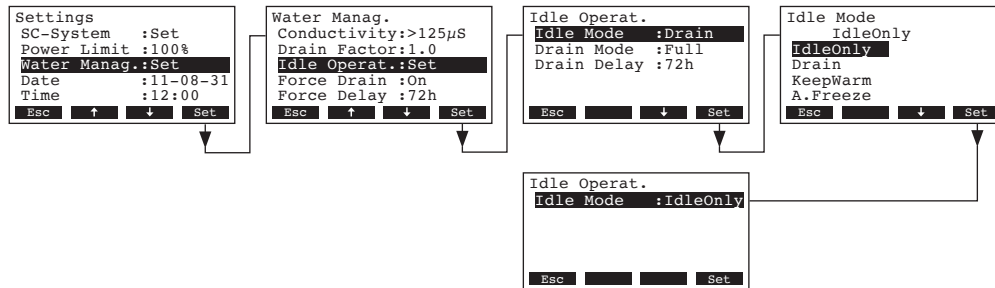

In the upcoming modification dialogue set Idle Mode to “IdleOnly”, then press the <Set> key.

– Standby operation with partial or complete draining of the steam cylinder

In this operating mode the cylinder is partly or fully drained after a certain time in standby operation.

Select “Idle Operat.” in the water management settings submenu, then press the <Set> key. In the upcoming Idle submenu set the parameters for standby operation with partial or complete draining of the steam cylinder.

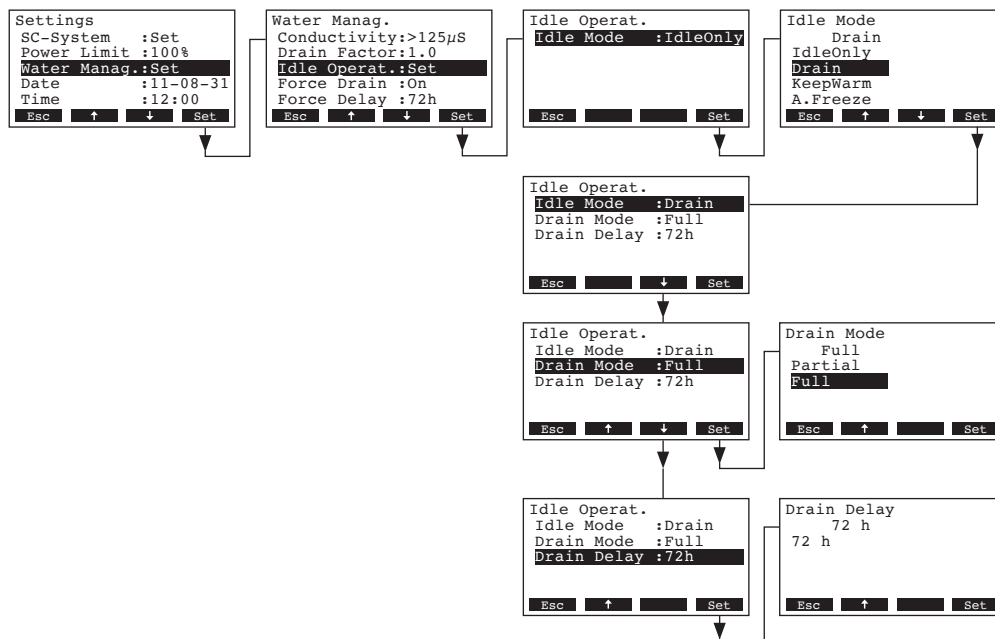

Settings:

- “Idle Mode”: “Drain”
- “Drain Mode”: “Full” (complete draining of the cylinder) or “Partial” (cylinder is drained so far that the water does not touch the electrodes any longer)

Important: with outdoor operation it is mandatory to set the drain mode to “Full”.

- **“Drain Delay”**: period of time in standby operation after which an automatic cylinder draining (partial or complete) takes place (Factory setting: 72 h., Setting range: 1...720 h).

Important: with **outdoor operation it is mandatory** to set the period of time in standby operation after which an automatic cylinder draining takes place to **1 hour**.

– **Standby operation with keep warm or keep humidity function**

In this operating mode the Nordmann AT4 D produces that much steam that the set temperature or the set humidity (caldarium operation) in the steam bath cabin can be held. After the set period of time in standby operation has elapsed the keep warm or keep humidity function is switched off.

Select **“Idle Operat.”** in the water management settings submenu, then press the **<Set>** key. In the upcoming Idle submenu set the parameters for standby operation with keep warm or keep humidity function.

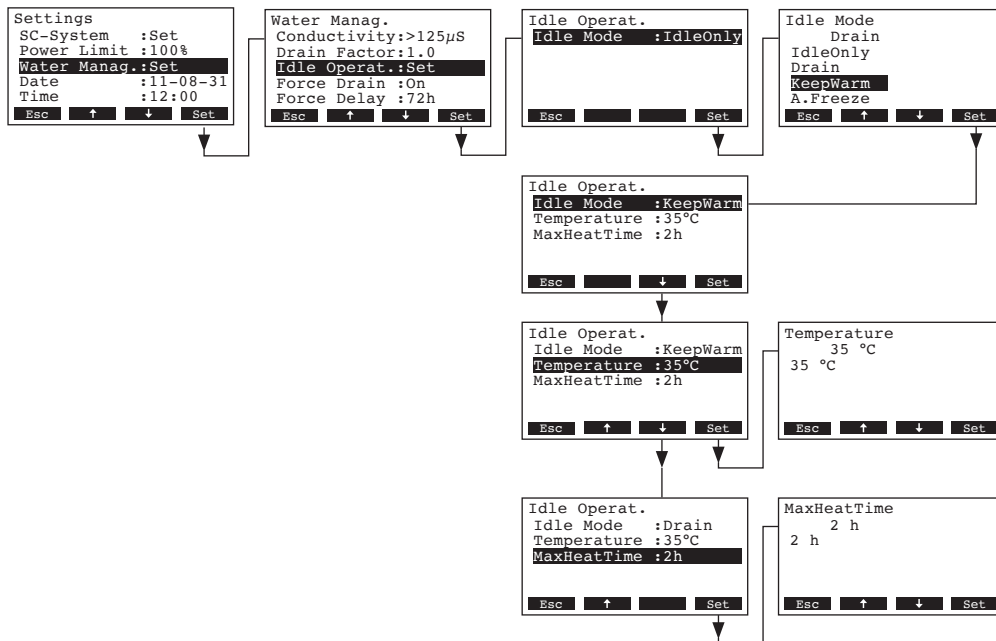

Settings:

- **“Idle Mode”**: **“KeepWarm”**
- **“Temperature”**: Desired steam bath cabin temperature, which is to be maintained during the set duration in the standby operation (Factory setting: 35 °C, Setting range: 10...50 °C)
or
“Humidity”: Desired humidity (caldarium operation), which is to be maintained during the set duration in the standby operation (Factory setting: 30 %rH, Setting range: 10...50 %rH)
- **“MaxHeatTime”**: Max. duration in standby operation the set temperature or humidity is maintained (Factory setting: 2 h, Setting range: 1...18 h)

– **Standby operation with anti freeze function**

In this operating mode the water in the cylinder is warmed up so far in standby operation that the water in the cylinder cannot freeze.

Note: the keep warm function works only, if the external safety chain is closed. Therefore this function may not be used for outdoor operation.

Select “Idle Operat.” in the water management settings submenu, then press the <Set> key. In the upcoming Idle submenu set the parameters for standby operation with anti freeze function.

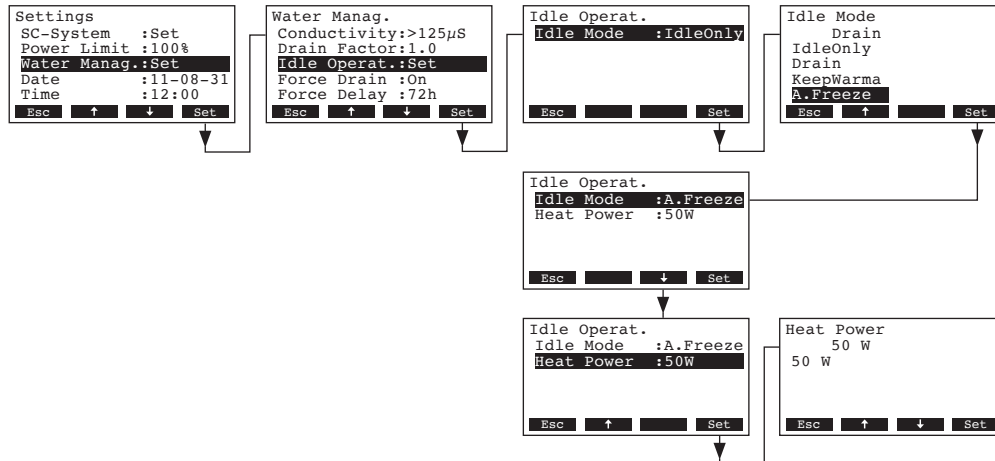

Settings:

- “Idle Mode”: “A.Freeze”
- “Heat Power”: heating power for anti freeze function (Factory setting: 50 W, Setting range: 10...200 W)

5.3.7.4 Activating/Deactivating the forced draining

Select “Force Drain” in the water management settings submenu, then press the <Set> key.

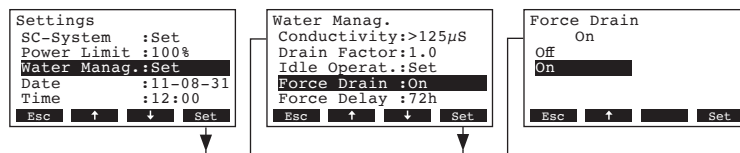

In the upcoming modification dialogue activate/deactivate the forced draining which takes place after a certain time of operation (see following setting).

Note: The forced draining takes place also during steam production.

- Factory setting: **Off**
- Options: **On** (Forced draining activated)
Off (Forced draining deactivated)

5.3.7.5 Setting the time of operation after which a forced draining takes place

Select “Force Delay” in the water management settings submenu, then press the <Set> key.

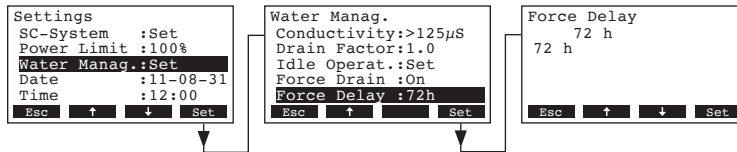

In the upcoming modification dialogue set the time of operation after which a forced draining takes place.

Factory setting: **72 hours**
Setting range: **1...720 hours**

5.3.8 Setting the date

Select “Date” in the user settings menu, then press the <Set> key.

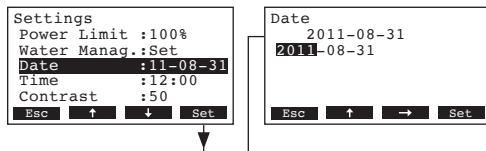

In the upcoming modification dialogue set the actual date (format:“yyyy-mm-dd”).

5.3.9 Setting the time

Select “Time” in the user settings menu, then press the <Set> key.

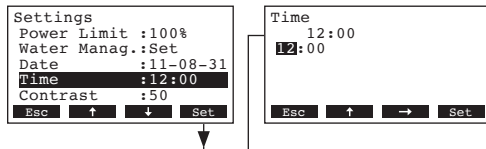

In the upcoming modification dialogue set the actual time (format:“hh:mm”).

5.3.10 Setting the display contrast

Note: this function is **not available** via the optional **remote terminal**.

Select “Contrast” in the user settings menu, then press the <Set> key.

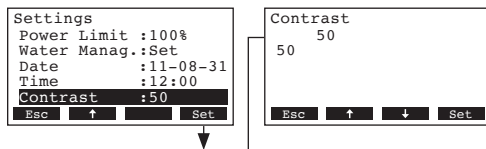

In the upcoming modification dialogue set the desired value for the display contrast.

Factory setting: **50**
Setting range: **25 (light) ...80 (dark)**

5.4 Modbus settings

Select the Modbus menu:

Path: **Main Menu > User > Password entry: 3562 > Modbus**

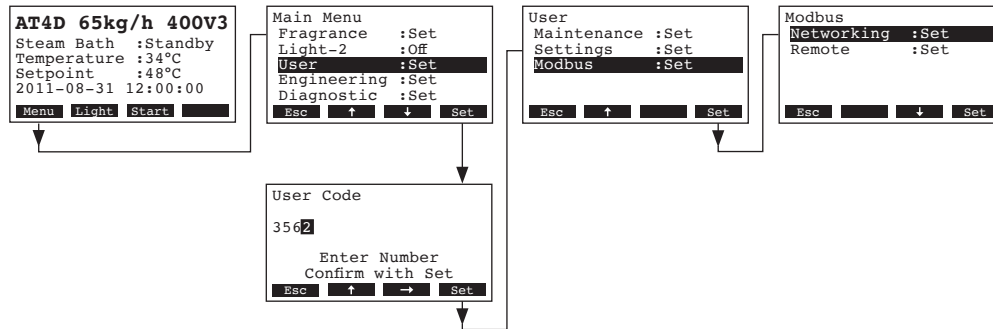

In the Modbus submenu you can set the parameters for Modbus networks or for the communication with the optional remote terminal. Detailed information on the different settings are found in the following chapters.

5.4.1 Settings for Modbus networks

Select “**Networking**” in the Modbus submenu, then press the **<Set>** key. In the upcoming modification dialogue adjust the settings for the Modbus network operation.

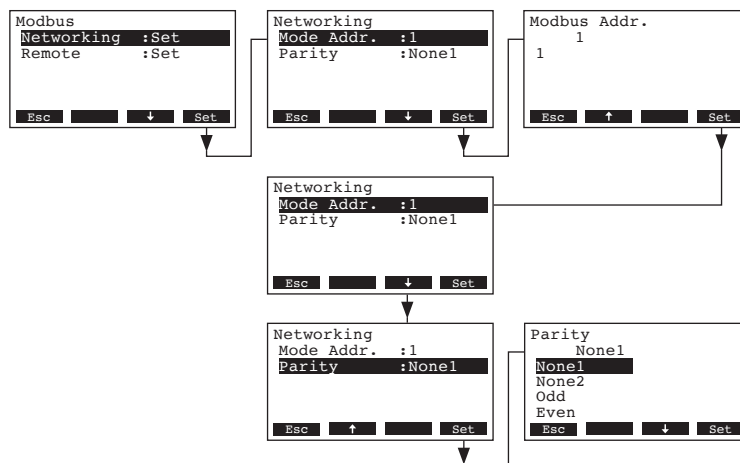

Settings:

- “**Modbus Addr.**”: Modbus address of the steam generator (Factory setting: 1, Setting range: 1...247).
- “**Parity**”: Parity bit for the data transmission (Factory setting: None1, Options: None1, None2, Odd, Even)

Note: for Modbus network operation the baud rate is set to 9600 baud as standard.

5.4.2 Settings for the communication with the optional remote terminal

Select “Remote” in the Modbus submenu, then press the <Set> key.

- Data upload

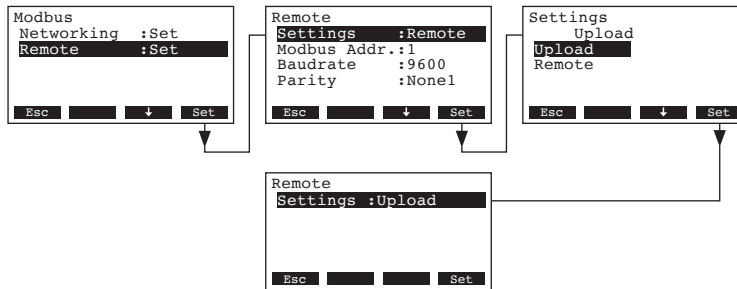

Note: this function is intended only for the service technician of your Nordmann representative.

- Settings for the communication with the optional remote terminal

Note: this function is **not available** via the optional remote terminal.

Select “Remote” in the Modbus submenu, then press the <Set> key. Then, adjust the settings for communication with the optional remote terminal.

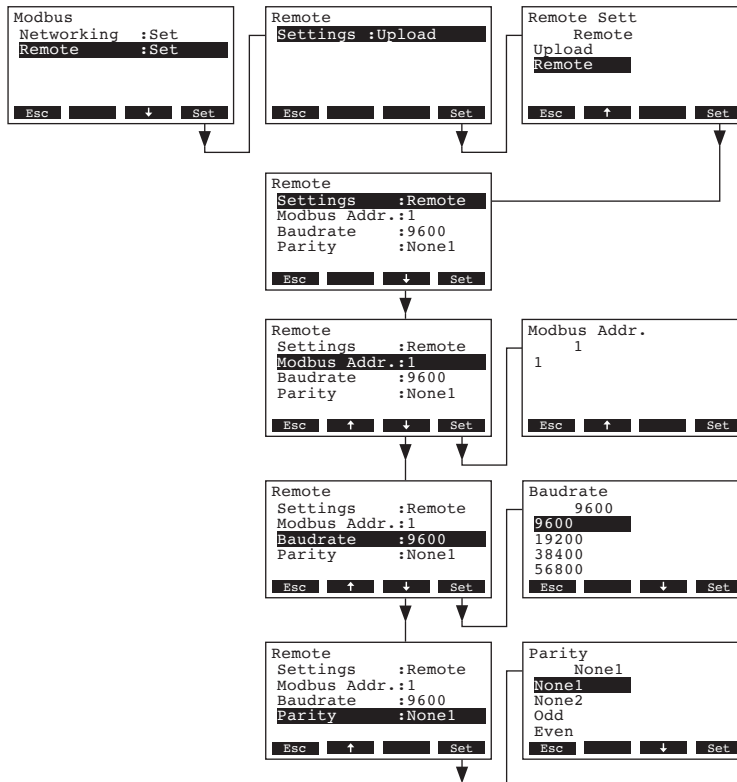

Settings:

- “Settings”: Remote
- “Modbus Addr.”: Modbus address of the steam generator (Factory setting: 1, Setting range: 1...247)
- “Baudrate”: Baudrate for the data transmission (Factory setting: 9600, Options: 9600, 19200, 38400, 57600)
- “Parity”: Parity bit for the data transmission (Factory setting: None1, Options: None1, None2, Odd, Even)

5.5 Diagnostic functions

5.5.1 Interrogation of the error history

The error messages generated by the last 20 malfunctions that occurred are saved in the error history list of the Nordmann AT4 D and can be interrogated.

Select the error history list:

Path: **Main Menu > Diagnostic > ErrorHistory**

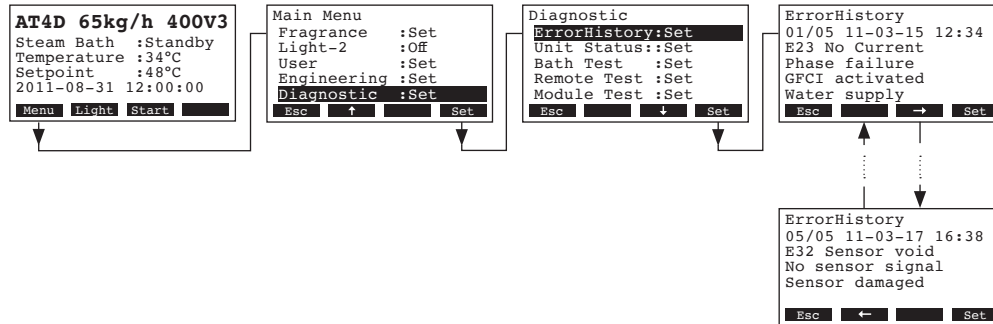

The last error that occurred is shown with:

- running number of the error
- date and time of occurrence
- error code (Warning: W..., Error: E...)
- error message
- additional info text regarding the error

Press <←> and <→> keys, in order to select further error messages in the list.

Press the <Esc> key several times to quit the error history list and to return to the standard operating display.

5.5.2 Interrogation of unit information

Select the list with the unit information:

Path: **Main Menu > Diagnostic > Unit Status**

Press <↓> and <↑> keys, in order to select the unit information available in the list:

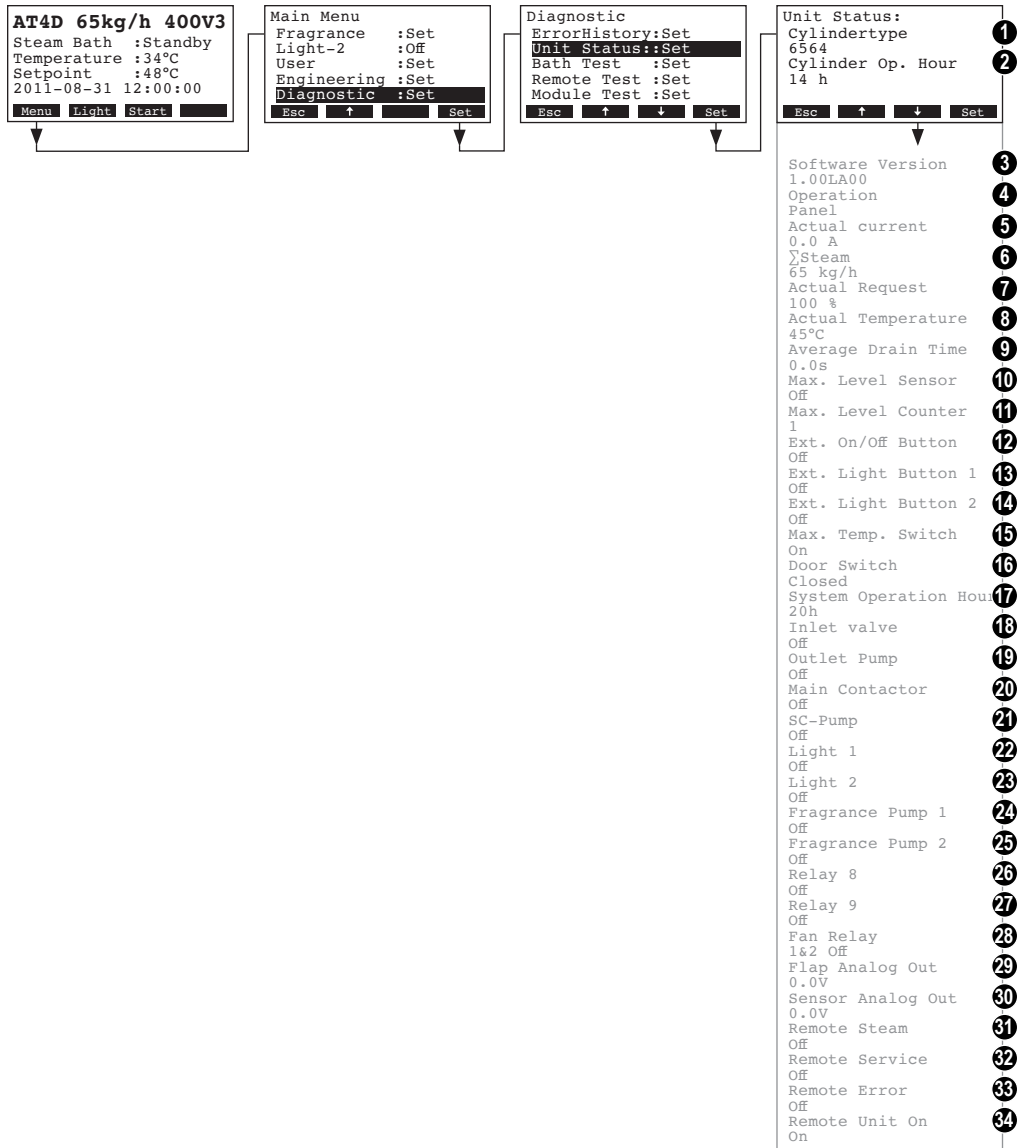

- 1 Type of the steam cylinder
- 2 Total operating hours of the steam cylinder
- 3 Software version
- 4 Set operating control mode
- 5 Actual nominal current
- 6 Actual steam capacity
- 7 Actual demand
- 8 Actual temperature or actual humidity (caldarium operation) in the steam bath cabin
- 9 Calculated average drain time in seconds
- 10 Actual status of the maximum level sensor
- 11 Counter showing the number of times the maximum level in the steam cylinder has been exceeded
- 12 Actual status of the external On/Off push-button
- 13 Actual status of the external push-button of light 1
- 14 Actual status of the external push-button of light 2
- 15 Actual status of the maximum temperature device

- 16 Actual status steam bath door switch
- 17 Total operating hours since the initial commissioning
- 18 Actual operating status inlet valve
- 19 Actual operating status drain pump
- 20 Actual operating status main contactor
- 21 Actual operating status SC pump
- 22 Actual operating status light 1
- 23 Actual operating status light 2
- 24 Actual operating status fragrance pump 1
- 25 Actual operating status fragrance pump 2
- 26 Actual operating status relay 8
- 27 Actual operating status relay 9
- 28 Actual operating status fan relay
- 29 Actual voltage on analog flap control output
- 30 Actual voltage on analog sensor output
- 31 Actual status remote relay "Steam"
- 32 Actual status remote relay "Service"
- 33 Actual status remote relay "Error"
- 34 Actual status remote relay "Unit on"

Press the <Esc> key several times to quit the unit information list and to return to the standard operating display.

5.5.3 Performing remote steam bath tests

Select the steam bath test:

Path: **Main Menu > Diagnostic > Bath Test**

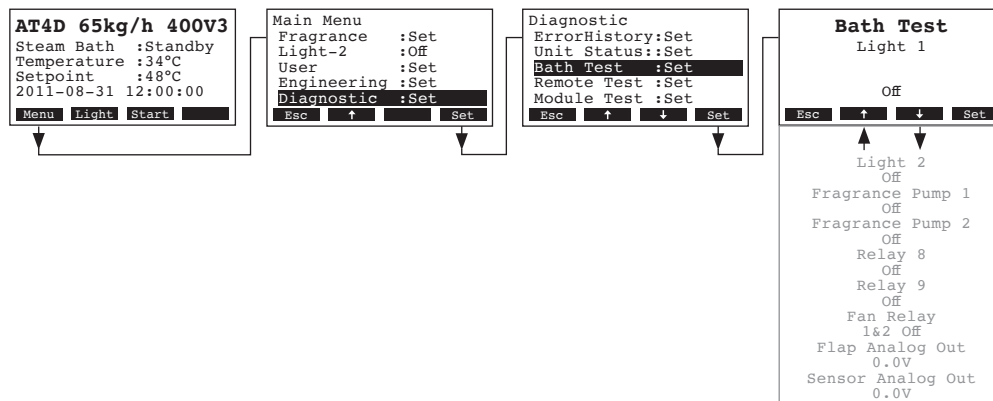

The list with the steam bath tests appears, the first steam bath test (Light 1) is shown. Press the <↓> and <↑> keys in order to select the further steam bath tests available and press the <Set> key to activate/deactivate the corresponding component for testing or to increase the shown value.

5.5.4 Performing remote relay tests

Select the remote test:

Path: **Main Menu > Diagnostic > Remote Test**

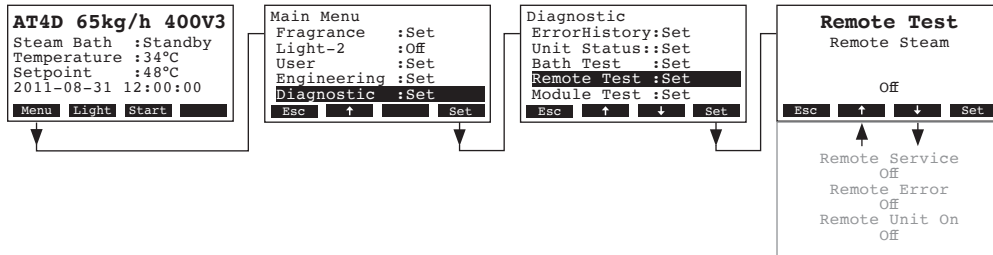

The list with the remote relay tests appears, the first relay test (steam) is shown.

Press the <↓> and <↑> keys in order to select the further relay tests available and press the <Set> key to activate/deactivate the corresponding relay for testing.

5.5.5 Performing Module tests

Note: this function is **not available** via the optional **remote terminal**.

Select the Module tests:

Path: **Main Menu > Diagnostic > Module Test**

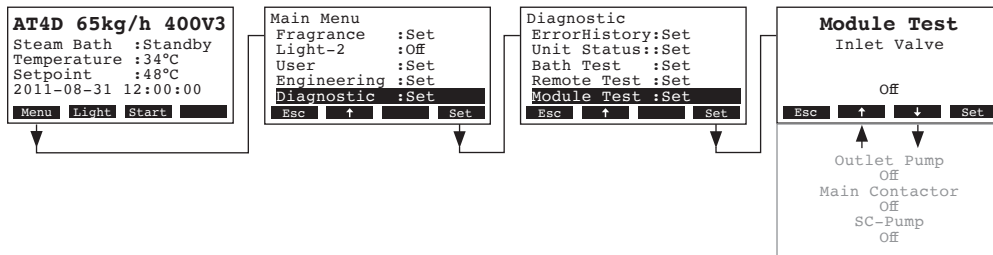

The list with the module tests appears, the first test (Inlet Valve) is shown.

Press the <↓> and <↑> keys in order to select the further module tests and press the <Set> key to activate/deactivate the corresponding component for testing.

5.6 Working with the remote terminal

5.6.1 Menu overview remote terminal

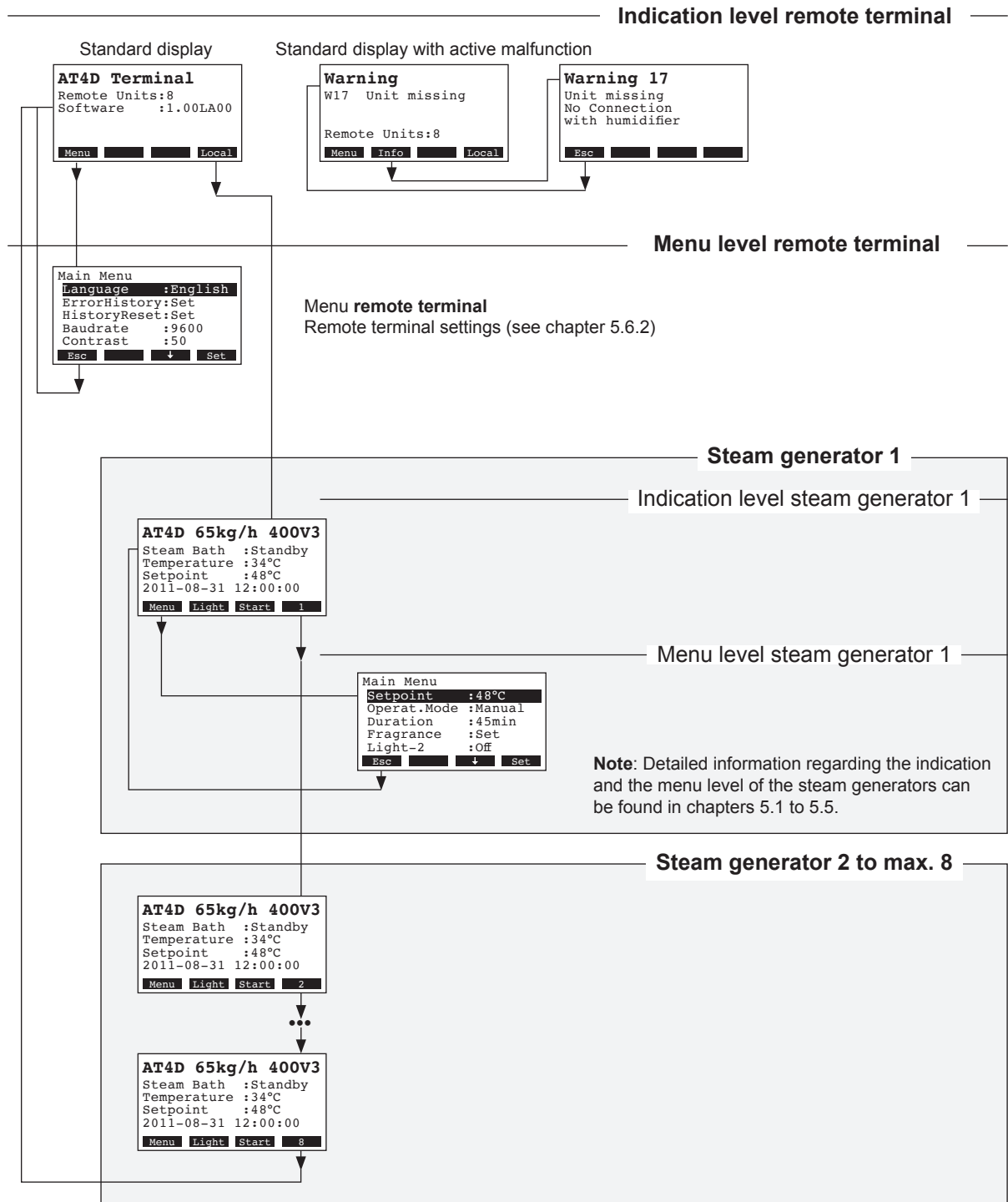

5.6.2 Remote terminal settings

5.6.2.1 Selecting the dialogue language

Select “Language” in the main menu, then press the <Set> key.

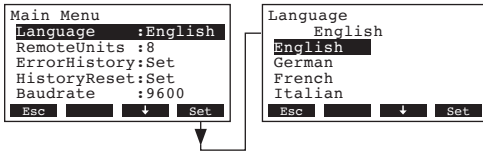

In the upcoming modification dialogue select the desired dialogue language. After confirmation, the unit automatically switches to the selected dialogue language.

Factory setting: **country specific**

Options: **divers languages**

5.6.2.2 Setting the number of steam generators connected to the remote terminal

Select “Remote Units” in the main menu, then press the <Set> key.

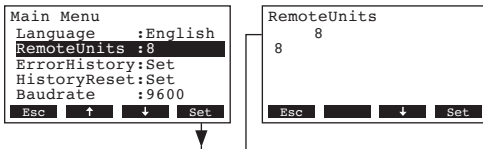

In the upcoming modification dialogue set the number of steam generators connected to the remote terminal.

Factory setting: **1**

Setting range: **1...8**

5.6.2.3 Interrogation of the error history of the remote terminal

The error messages generated by the last 20 malfunctions that occurred are saved in the error history list of the remote terminal and can be interrogated.

Select “ErrorHistory” in the main menu, then press the <Set> key.

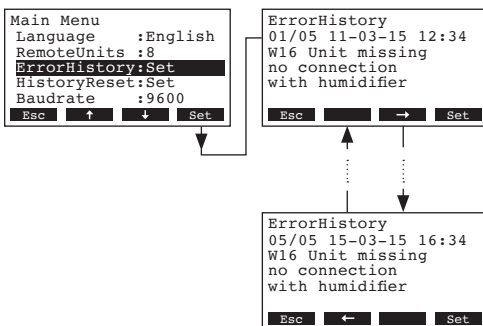

The last error that occurred is shown with:

- running number of the error
- date and time of occurrence
- error code (Warning: W..., Error: E...)
- error message
- additional info text regarding the error

Press <←> and <→> keys, in order to select further error messages in the list.

Press the **<Esc>** key several times to quit the error history list and to return to the standard operating display.

5.6.2.4 Resetting the error history list of the remote terminal

Select **"HistoryReset"** in the main menu, then press the **<Set>** key.

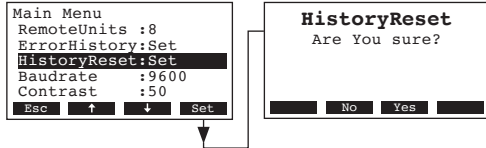

The reset dialogue appears in the display. Press the **<Yes>** key in order to **reset the error history list**.

Note: By pressing the **<No>** key the reset procedure can be aborted. The remote terminal returns to the main menu.

5.6.2.5 Setting the baudrate

Select **"Baudrate"** in the main menu, then press the **<Set>** key.

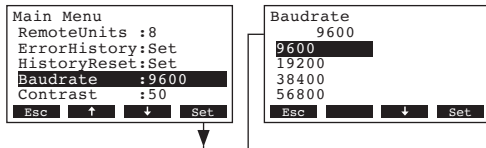

In the upcoming modification dialogue set the baudrate for the communication with the steam generator controls.

Factory setting: **9600**
Options: **9600, 19200, 38400, 57600**

5.6.2.6 Setting the display contrast

Select **"Contrast"** in the main menu, then press the **<Set>** key.

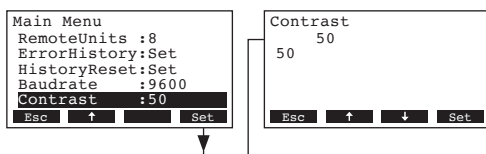

In the upcoming modification dialogue set the desired value for the display contrast of the remote terminal.

Factory setting: **50**
Setting range: **25 (light) ...80 (dark)**

6 Maintenance

6.1 Important notes on maintenance

Qualification of personnel

All maintenance work must be carried out only by **well qualified and trained personnel authorised by the owner**. It is the owner's responsibility to verify proper qualification of the personnel.

General note

The instructions and details for maintenance work must be followed and upheld.

Only the maintenance work described in this documentation may be carried out.

Only use original Nordmann spare parts to replace faulty parts.

Safety

Some maintenance work requires removal of the unit covers. Please note the following:



DANGER!
Danger of electric hazard!

You may get in touch with live parts when the unit is open. Touching live parts may cause severe injury or even lethal violation.

Prevention: Before carrying out any maintenance work set the Nordmann AT4 D out of operation as described in chapter 4.4 (switch off the unit, disconnect it from the mains and stop the water supply) and secure the unit against inadvertent power-up.

CAUTION!

The electronic components inside the steam generator are very sensitive to electrostatic discharge.

Prevention: Before carrying out any maintenance work to the electrical or electronic equipment of the steam generator, appropriate measures must be taken to protect the respective components against damage caused by electrostatic discharge (ESD protection).

6.2 Maintenance list

To maintain operational safety the Nordmann AT4 D steam generator must be maintained at regular intervals. This is differentiated between the **first maintenance after approx. 500 operating hours (I)**, **steam cylinder replacement after the yellow LED lights (II)** and **annual maintenance (III)**.

Below you will find a summary of the work to be carried out for each of the three maintenance stages.

Components	Interval			Work to be done
	I	II	III	
Steam cylinder		X		Remove and replace.
Drain pump			X	Remove, disassemble and clean, replace if necessary.
Steam cylinder receptacle			X	Inspect, clean if necessary.
Inlet valve			X	Remove and clean filter insert, replace if necessary.
Drain cup			X	Remove and clean if necessary
Drain pipe and siphon			X	Inspect, clean if necessary (decalcify and rinse out).
Steam installation	X		X	Inspect steam and condensate hoses for cracks and to see that they are correctly attached, replace faulty hoses.
Water installation	X		X	Inspect water hoses in the unit for cracks and to see that they are correctly attached, replace faulty hoses. Check supply pipe is tight, make tight if necessary. Clean water filter, if available.
Electrical installation	X		X	Check all cables in the unit are firmly positioned and examine status of insulation.

6.3 Removing and installing parts for maintenance

6.3.1 Removal and installation of the steam cylinder

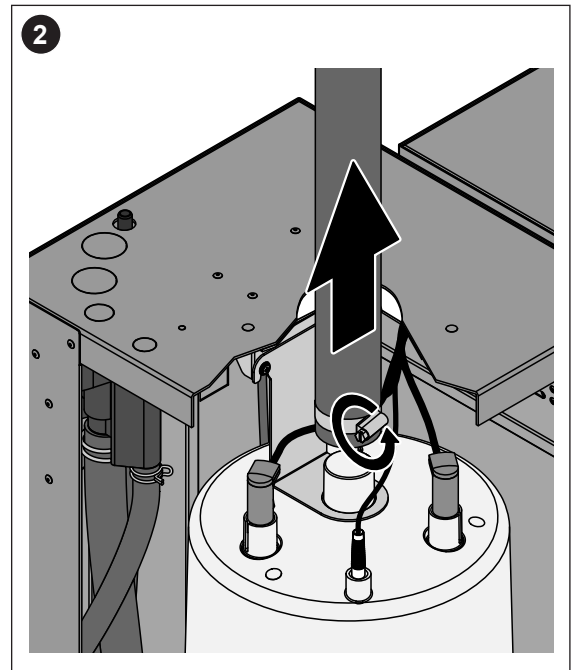
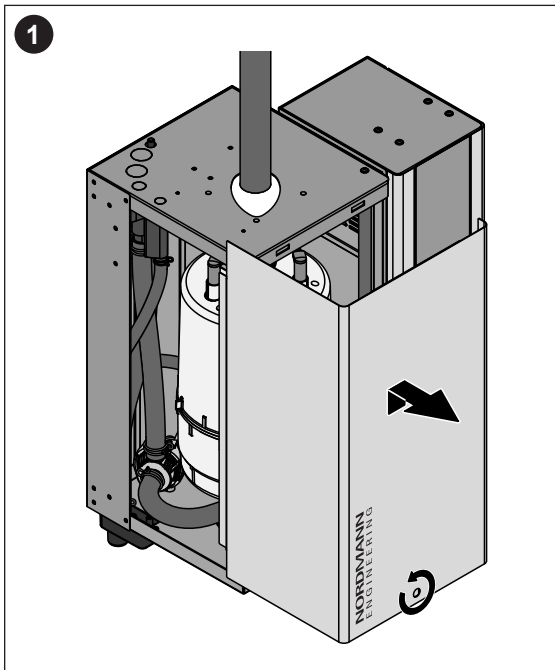

1. Undo the screw fixing the front panel to the unit using a screwdriver, then remove the front panel.
2. Release the hose clamp on the steam hose using a screwdriver, then detach the steam hose from the steam outlet connection of the steam cylinder.

Units with steam hose connector with condensate trap (option CT..., not shown): release the two hose clamps on the rubber sleeve using a screwdriver, then detach the rubber sleeve from the connection in the unit cover and from the steam outlet connection of the steam cylinder.

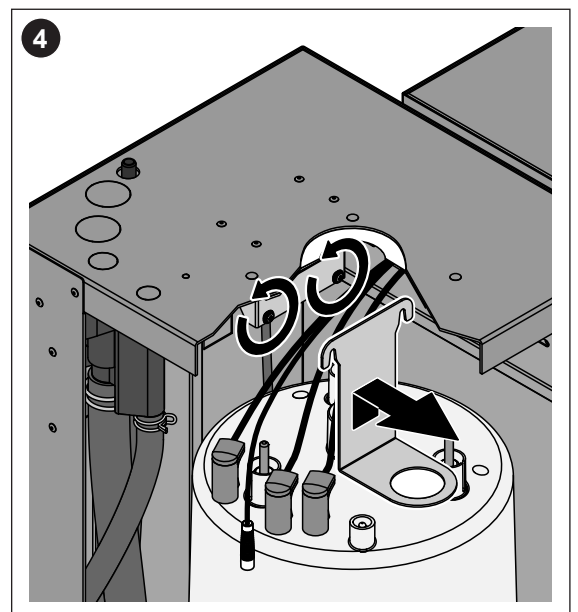
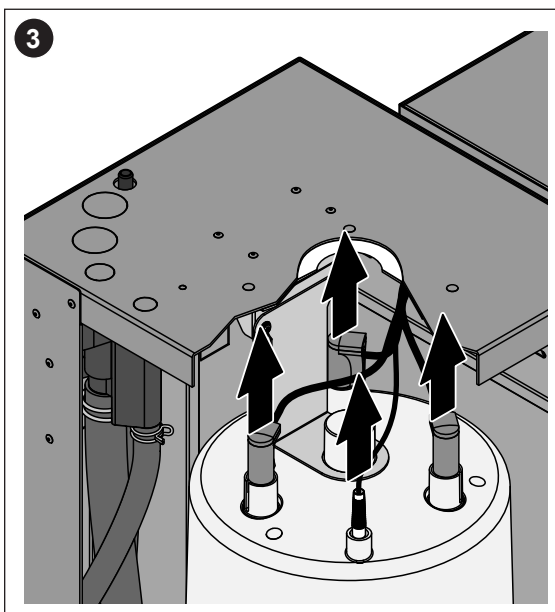

3. Remove all plugs from the electrodes and from the level sensor.
4. Loosen the screws of the steam cylinder fixing device by a few turns, then push the fixing device upwards until it comes loose and remove it.

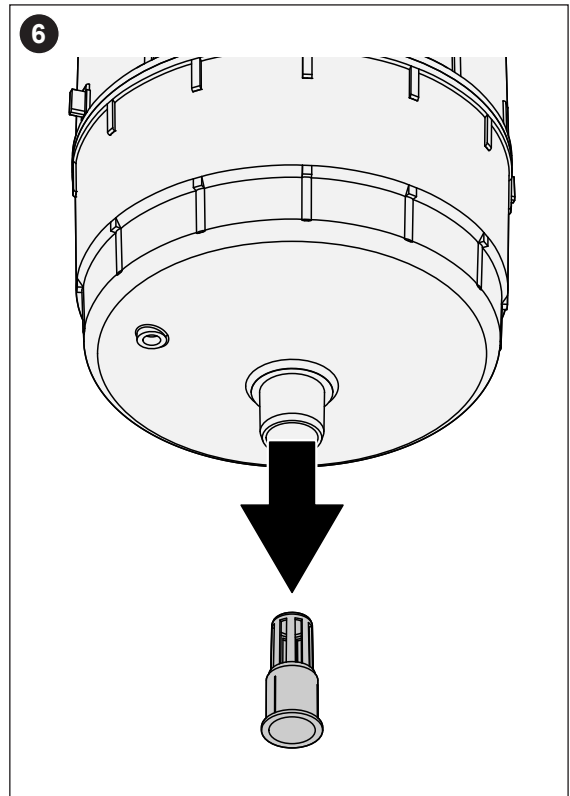
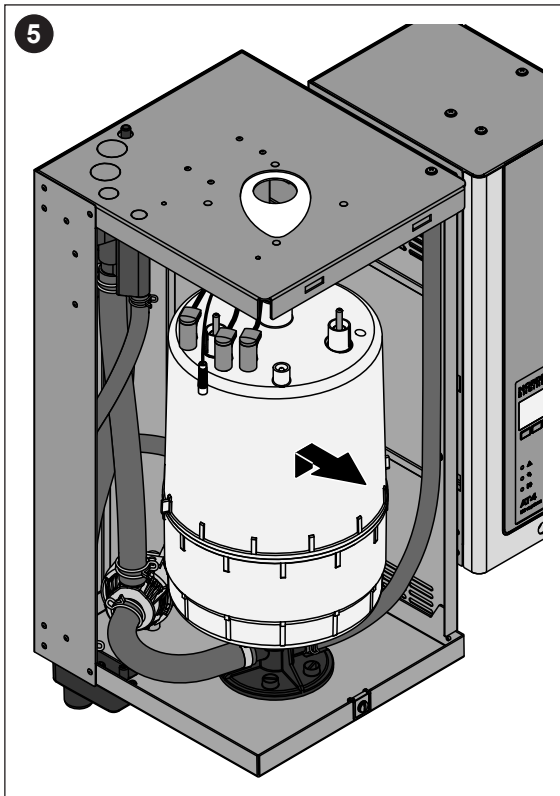

5. Carefully lift steam cylinder away from the cylinder receptacle, then remove it to the front.

CAUTION!

Put steam cylinder down carefully to avoid damage to the lower connection piece!

6. Carefully pull the drain screen out of the drain outlet of the steam cylinder. **Note:** this step must only be carried out if the drain screen is clogged (see chapter 7.2.2 “Unit faults”) and the steam cylinder can still be used.

Installation of the steam cylinder follows the reverse sequence. **Observe the following:**

- Before installing the steam cylinder in the unit, check the O-ring of the cylinder receptacle for damage and replace if necessary.
- Moisten the O-ring of the cylinder receptacle with water (do not use grease or oil), then insert steam cylinder into the socket and push it down to the stop.
- Attach the electrode plugs and the level sensor plug to the respective electrode and sensor connections in accordance with colour code (see table below).

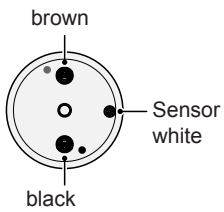
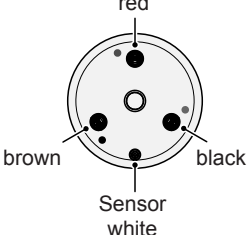
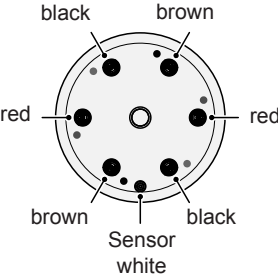
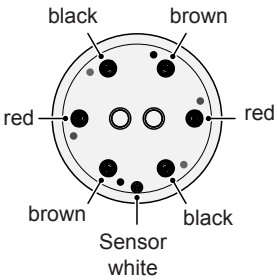
Steam cylinder type			
522A 822A	532A / 534A 832A / 834A 1532A / 1534A	2362A / 2364A 3262A / 3264A	4564A / 6564A
			

- Fasten steam hose on the connector of the steam cylinder with hose clamps.

CAUTION!

- A leaky steam hose can cause damage due to moisture inside the unit.
- The outlet connector of the steam cylinder is made of plastic. **Do not overtighten** the hose clamp on the steam connector of the steam cylinder.

6.3.2 Removal and installation of the drain cup

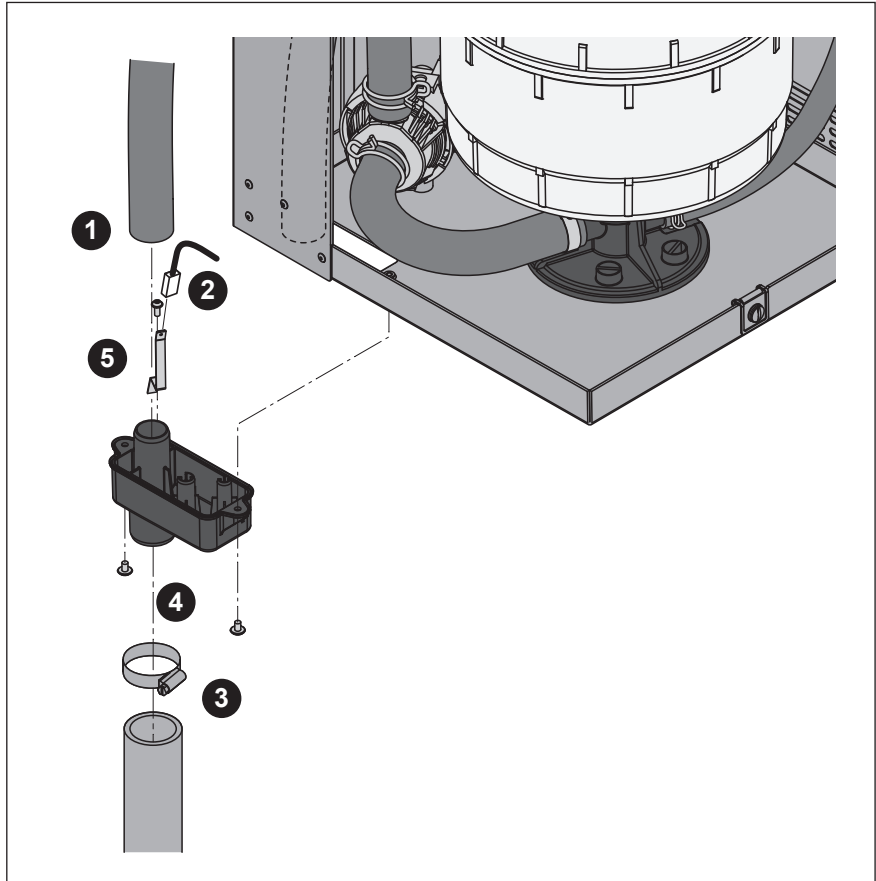

1. Remove overflow hose from the connector on the water cup.
2. Remove grounding cable from the grounding lance.
3. Release the hose clamp, then remove water drain hose from the connector on the water cup.
4. Undo the two screws fixing the drain cup to the unit using a screwdriver, then remove the drain cup downwards.
5. Undo the screw, then remove grounding lance.

Installation of the drain cup follows the reverse sequence.

Important: reattach grounding cable to grounding lance.

6.3.3 Removal and installation of the water cup and the water hoses

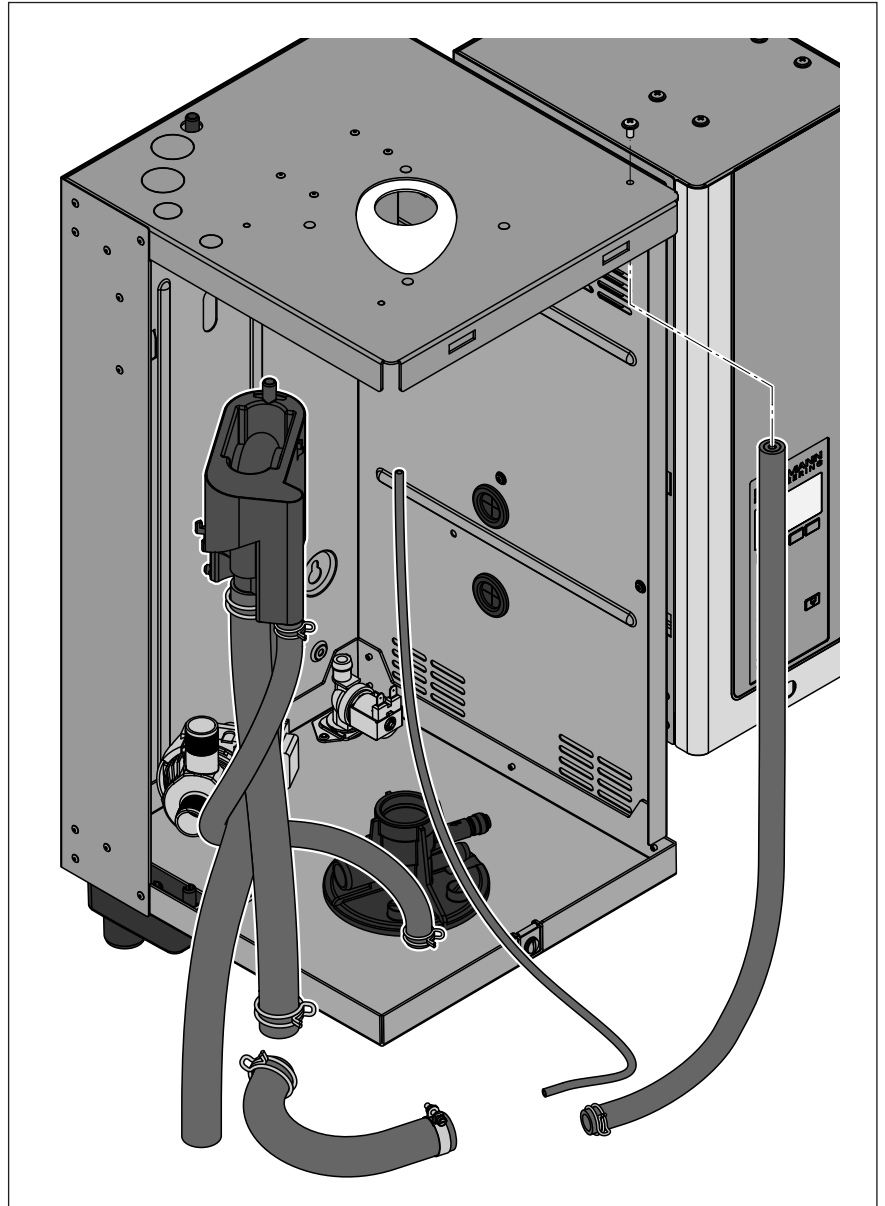

For removing the water cup and the water hoses the steam cylinder must be removed first (see chapter 6.3.1).

1. Release hose clamps, then disconnect all hoses from the corresponding connectors and remove the hoses.

Note: The hoses connected to the water cup may also be removed together with the water cup (see illustration) and then disconnected from the connectors of the water cup outside the unit.

2. **Carefully** pull fixing clip of the water cup to the front, then push water cup down from the holding device and remove it to the front.

The **installation** of the water cup and the water hoses follows the reverse sequence. Before fixing the water hoses to the connector using the hose clamps, align the hoses in a way that they are not twisted.

6.3.4 Removal and installation of the drain pump

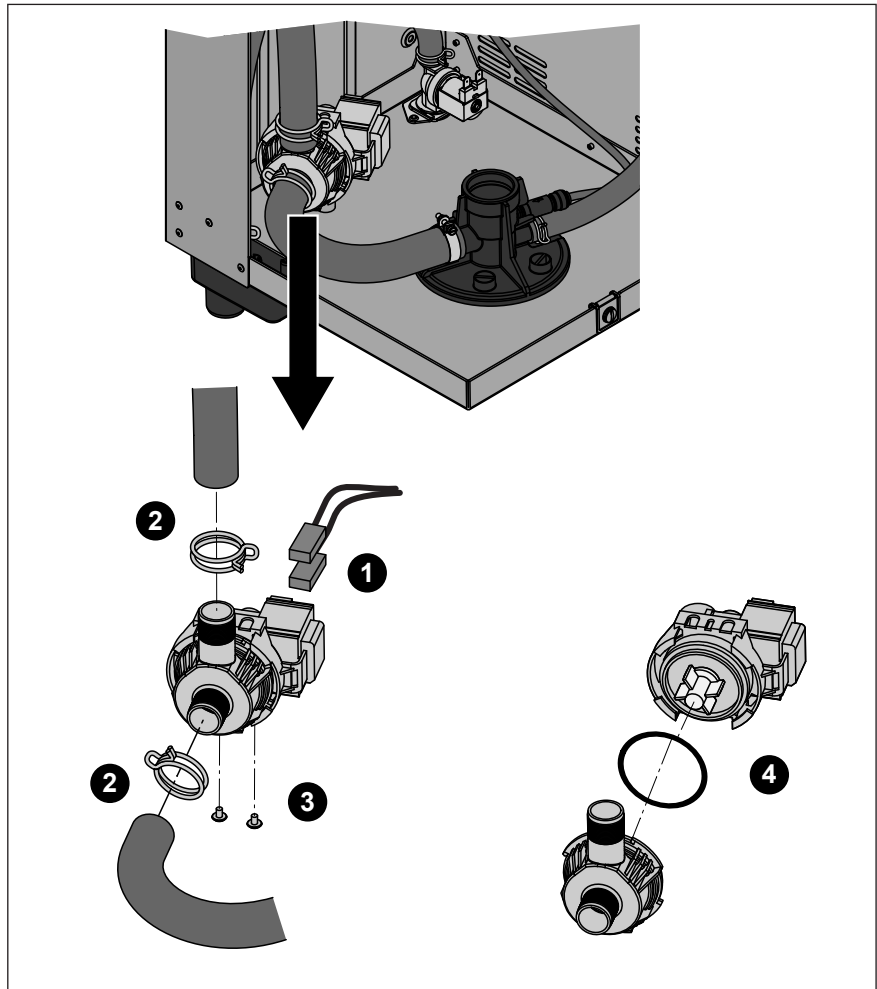

For removing the drain pump the steam cylinder must be removed first (see chapter 6.3.1).

1. Detach electric cables (polarity of the cables must not be observed).
2. Release hose clamps and remove the hoses from the connectors.
3. Undo the two screws on the bottom of the housing with Phillips screwdriver, then remove drain pump.
4. Separate the electric motor from the pump body: release the lock on the bayonet catch, then counter-rotate the electric motor and the pump body.

The **assembly** and the **installation** of the drain pump follows the reverse sequence. Before assembling the pump, check O-ring for damage and replace if necessary. Then, place the O-ring on the centering collar and moisten the O-ring with water.

6.3.5 Removal and installation of the inlet valve

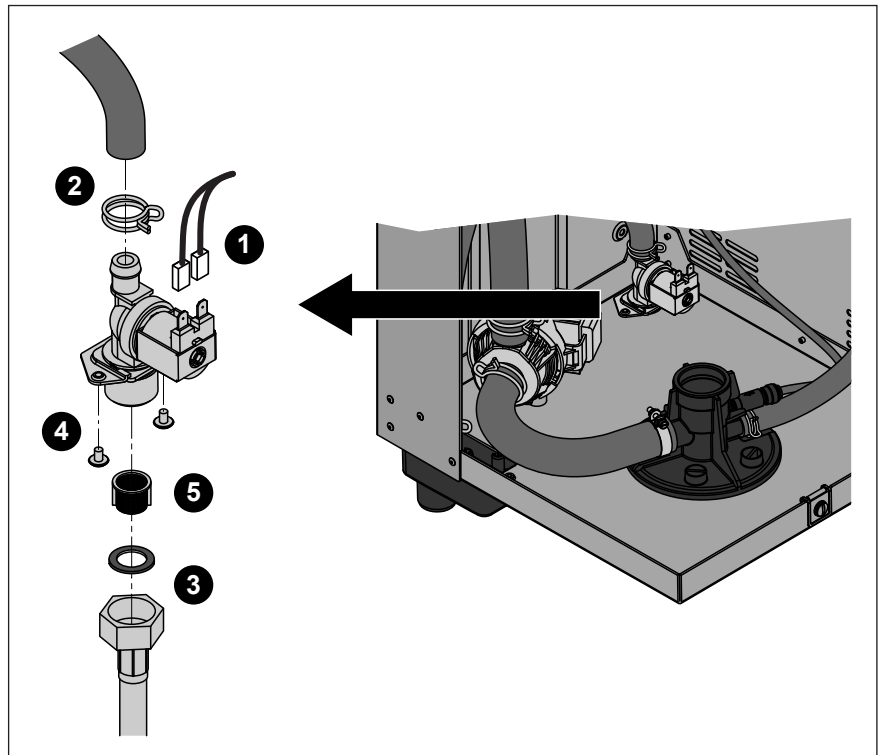

For removing the inlet valve the steam cylinder must be removed first (see chapter 6.3.1).

1. Detach electric cables (polarity of the cables must not be observed).
2. Release hose clamp and remove the hose from the connector.
3. Unlock union nut of the water pipe and remove water pipe.
4. Undo the two screws on the bottom of the housing with Phillips screwdriver, then remove inlet valve.
5. Remove strainer insert with pointed pliers.

The **installation** of the inlet valve follows the reverse sequence. The union nut of the water pipe must be tightened by hand only.

6.3.6 Removal and installation of the cylinder receptacle

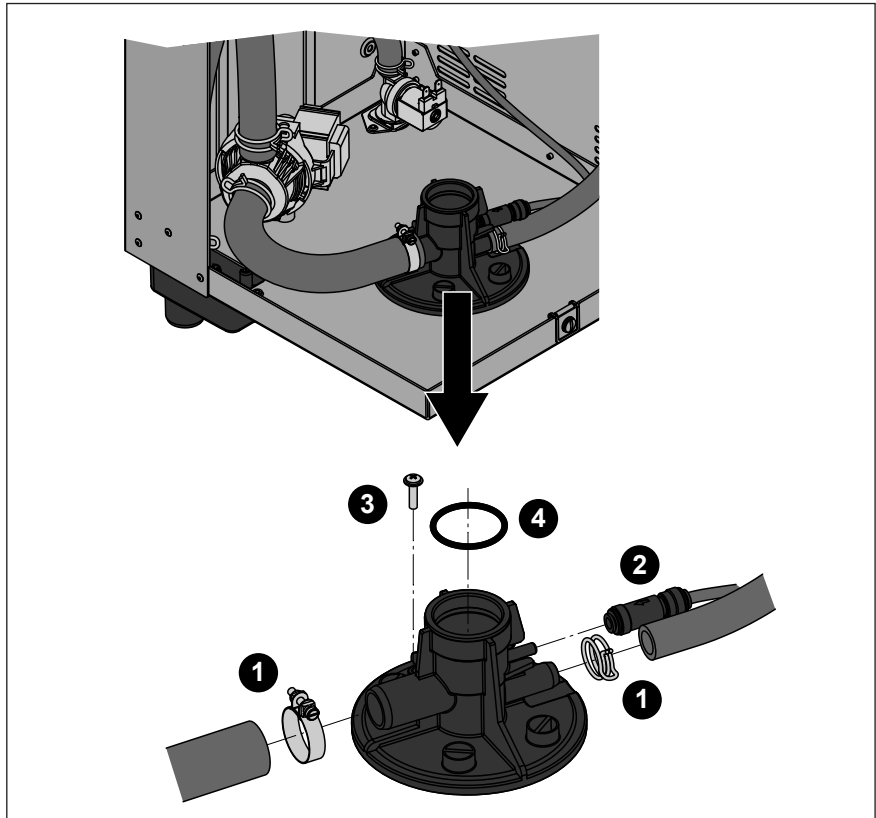

For removing the cylinder receptacle the steam cylinder must be removed first (see chapter 6.3.1).

1. Release hose clamps and remove hoses from the connectors.
2. Remove hose from SC pump together with the check valve from the corresponding connector on the cylinder receptacle.
3. Undo the screw fixing cylinder receptacle to the bottom of the housing with Phillips screwdriver. Then, turn cylinder receptacle counter clockwise to the stop and remove cylinder receptacle upwards.
4. Remove O-ring from the cylinder receptacle.

The **installation** of the cylinder receptacle follows the reverse sequence. Before mounting the cylinder receptacle, check O-ring for damage and replace if necessary.

6.4 Notes on cleaning the unit components

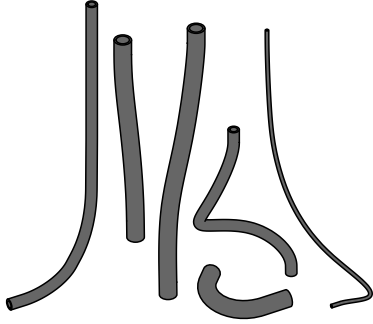
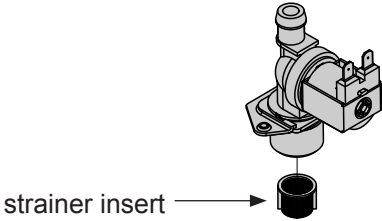
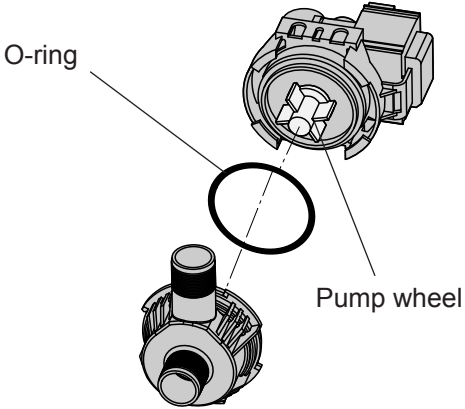
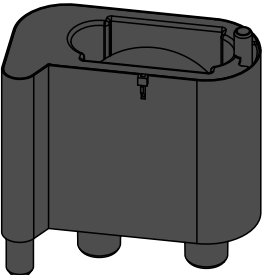
Unit component	What to clean and how to clean
<p>Water hoses</p> 	<ul style="list-style-type: none"> Remove any limescale by slightly knocking on the tubes using a rubber hammer. Then, rinse the tubes well with hot tap water.
<p>Inlet valve</p>  <p>strainer insert →</p>	<ul style="list-style-type: none"> Use a brush (do not use a wire brush) to remove any limescale inside the inlet valve and on the strainer. Wash inlet valve and strainer insert with a lukewarm soap solution, then rinse well with tap water. Let the inlet valve dry before reinstallation!
<p>Drain pump</p>  <p>O-ring</p> <p>Pump wheel</p>	<ul style="list-style-type: none"> Use a brush to remove any limescale from the pump housing and the pump wheel (do not use a wire brush). Then, wipe pump wheel with a damp cloth. Wash the pump housing with a lukewarm soap solution and rinse well with tap water. Let the drain pump dry before reinstallation!
<p>Water cup</p> 	<ul style="list-style-type: none"> Remove any limescale from the water cup and its connectors using a brush (do not use a wire brush). If the water cup is heavily calcified, place it in an 8% formic acid solution (observe safety notes in chapter 6.5), until the limescale comes off. Wash the water cup with a lukewarm soap solution and rinse well with tap water.

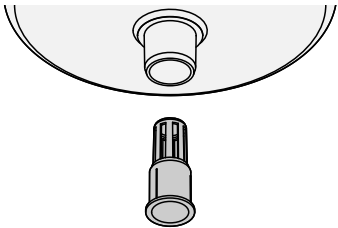
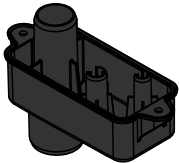
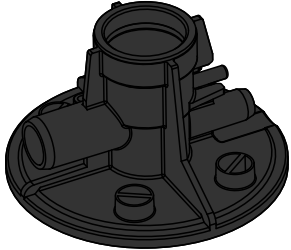
Unit component	What to clean and how to clean
<p data-bbox="252 212 703 241">Drain screen of the steam cylinder</p> 	<ul data-bbox="746 212 1430 492" style="list-style-type: none"> • Remove any limescale from the drain screen using a brush (do not use a wire brush) and remove loose limescale inside the drain connector of the steam cylinder. If the drain screen is heavily calcified, place it in an 8% formic acid solution (observe safety notes in chapter 6.5), until the limescale comes off. • Wash the drain screen with a lukewarm soap solution and rinse well with tap water.
<p data-bbox="252 517 379 546">Drain cup</p> 	<ul data-bbox="746 517 1430 828" style="list-style-type: none"> • Use a brush to remove any limescale from the drain cup and the receptacle on the bottom side of the unit (do not use a wire brush). If the drain cup is heavily calcified, place it in an 8% formic acid solution (observe safety notes in chapter 6.5), until the limescale comes off. • Wash the drain cup and the receptacle on the bottom side of the unit with a lukewarm soap solution, rinse the parts well with tap water.
<p data-bbox="252 853 504 882">Cylinder receptacle</p> 	<ul data-bbox="746 853 1430 1133" style="list-style-type: none"> • Remove any limescale from the cylinder receptacle and its connectors using a brush (do not use a wire brush). If the cylinder receptacle is heavily calcified, place it in an 8% formic acid solution (observe safety notes in chapter 6.5), until the limescale comes off. • Wash the cylinder receptacle with a lukewarm soap solution and rinse well with tap water.
<p data-bbox="252 1180 488 1245">Interior of the unit (water side only)</p>	<p data-bbox="746 1180 1430 1245">Wipe the interior of the unit with a damp cloth without using any cleaning agent.</p> <p data-bbox="746 1256 1430 1321">CAUTION: Take care that the electrical connections and the electronic components remain dry!</p>

6.5 Notes on cleaning agents

Only use cleaning agents stated in the table above. The use of disinfectants is only permitted if they do not leave any toxic residues. In any case the parts must be thoroughly rinsed with water after cleaning.



WARNING!

Formic acid is indeed harmless to the skin, but it attacks the mucous membranes. Therefore prevent your eyes and respiratory tracts from getting in touch with the acid and its vapours (wear goggles and work in a well ventilated room or outside).

CAUTION!

Do not use any solvents, aromatized or halogenised hydrocarbons or other aggressive substances as they may cause damage to the components of the unit.

It is mandatory to observe and comply with the information and instructions regarding cleaning agents. Observe in particular: all information relating to the protection of personnel, environmental protection and restrictions regarding usage.

6.6 Resetting the maintenance indication

After completing maintenance work, the **maintenance indication** (yellow LED lights) must be reset:

1. Select the maintenance menu:

Path: **Main Menu > User > Password: 3562 > Maintenance**

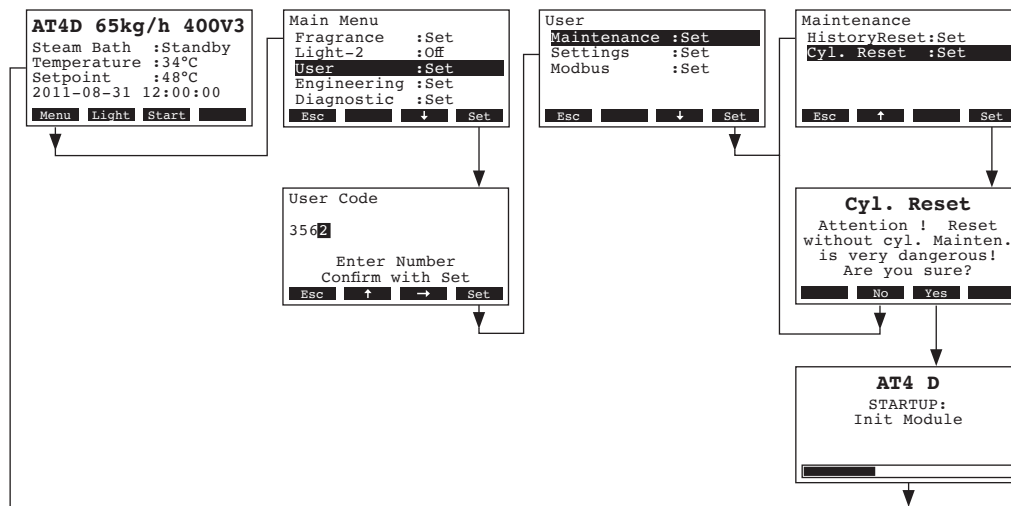

2. Select **"Cyl. Reset"**, then press the **<Set>** key.
3. The reset dialogue appears in the display. Press the **<Yes>** key to reset the **maintenance counter** or the **maintenance indication** respectively. The **maintenance counter** and the **maintenance indication** are reset and the control unit is restarted.

Note: by pressing the **<No>** key the reset procedure can be aborted and the display and control unit returns to the maintenance menu. To return to the standard operating display press the **<Esc>** key several times.

7 Fault elimination

7.1 Fault indication

Malfunctions during operation are indicated by the “**danger symbol**” in the **standard operating display**. If there is a severe malfunction (unit is blocked) the **red LED lights** additionally.

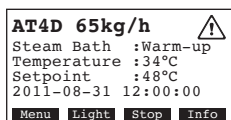

By pressing the **<Info>** key additional information can be displayed for each active warning and/or error message. Press the **<←>** and **<→>** keys, in order to scroll between the active warning and/or error messages.

– Warning messages

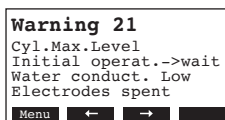

The control of the Nordmann AT4 D checks whether there is a temporary problem (e.g. water supply interrupted for a short time) or whether it can resolve the problem by taking necessary measures. If the cause of the malfunction disappears of its own accord or if the control can repair the malfunction, the alarm message will automatically switch off. If the cause of the malfunction does not disappear even after a longer period of time, a error message is triggered.

– Error messages

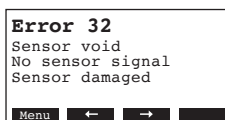

Additionally to the error message the **red LED lights**. Further operation is normally not possible any longer, the unit is blocked. To eliminate the malfunction see chapter 7.2 and 7.3.

Note: After eliminating the malfunction the error message must be reset (see chapter 7.4).

Note: if you want to see further information of an active warning or error message of a steam generator on the **optional remote terminal**, select “Exception” in the diagnostic menu of the appropriate steam generator (appears only on the remote terminal), then press **<Set>** key:

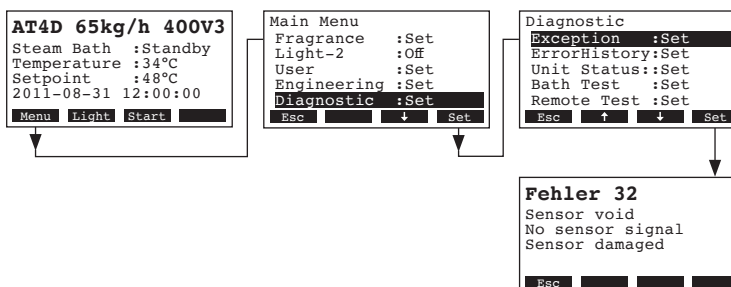

7.2 Malfunction lists

Important! Most operational malfunctions are not caused by faulty equipment but rather by improper installation or disregarding of planning guidelines. Therefore, a complete fault diagnosis always involves a thorough examination of the entire system. Often, the steam hose connection has not been properly executed, or the fault lies with the humidity control system.

7.2.1 System faults

Warning		Error		Cause	Remedy
LED	Display	LED	Display		
		CF card missing (Test run possible)			
—	—	red lights	Error E1: CF card Missing	No CF card installed on the control board.	Install CF card or start test run.
		CF card is empty			
—	—	red lights	Error E2: CF card Empty	No data stored on the CF card.	Install new CF card.
		CF card is defective			
—	—	red lights	Error E3: CF card Invalid	Invalid data stored on the CF card.	Install new CF card.
		CF card is incompatible			
—	—	red lights	Error E4: CF card incompat	The installed CF card is not compatible with the hardware of the unit or with the basic settings of the control electronics.	Install correct CF card. Let your Nordmann service technician adjust the basic settings.
		Steam bath board not connected			
—	—	red lights	Error E5: Module W Missing	Steam bath board not connected to the control board, the system does not start.	Connect steam bath board to the control board.
		Hardware fault			
—	—	red lights	Error E10: Flash R/W Fault	Control board defective.	Replace control board.
—	—		Error E11: Clock R/W Fault	Backup battery on control board discharged.	Let have the backup battery be replaced (see chapter 7.5).
		Max. heating time exceeded			
—	—	red lights	Error E13: Max Heating	Steam bath was in operation too long.	Check week timer. Increase maximum heating time.
		Steam bath door open too long			
—	—	red lights	Error E14: Door open	Steam bath door was open too long.	Close steam bath door. Check door switch. If no door control is connected: Check whether a cable bridge is connected on the corresponding contacts on the steam bath board.
		Program fault			
—	—	red lights	Error E15: Program Fault	Program fault, steam generator is blocked.	Please contact your Nordmann supplier.
Test Mode active					
—	Warning W16: Test Mode Active	—	—	Diagnostic mode active (Remote Test, Module Test etc.)	Quit diagnostic mode.

Warning		Error		Cause	Remedy
LED	Display	LED	Display		
Humidifier missing					
—	Warning W17: Unit Missing Note: This warning is shown only on the remote terminal.	—	—	The optional remote terminal does not have connection to one or more units.	Check connecting cable. Check/correctly set Modbus settings (modbus address, interface parameters).
Temperature measurement instable					
—	—	red lights	Error E18: Temperat.Instab.	Instable temperature measurement due to a manipulation at the temperature sensor in the steam bath cabin.	Check temperature sensor in the steam bath cabin.

7.2.2 Unit faults

Warning		Error		Cause	Remedy
LED	Display	LED	Display		
Maximum temperature switch has triggered					
—	—	red lights	Error E20: Temp.Fuse	Maximum temperature switch has triggered	Check temperature in the steam bath cabin.
				Maximum temperature switch defective or not connected.	Check/replace maximum temperatureswitch or correctly connect the switch.
Max. filling level of steam cylinder reached					
—	Warning W21: Cyl.Max.Level	red lights	Error E21: Cyl.Max.&NoCurr	Water conductivity too low (after initial operation).	Wait until the mineral content of the cylinder has increased
				Water conductivity too low for the selected steam cylinder type.	Select correct steam cylinder type.
				Phase failure heating voltage.	Check service switch in the mains supply line and switch on if applicable. Check mains fuse(s) and replace if applicable.
Permissible filling time exceeded (20 minutes)					
—	Warning W22: Max. Filltime	red lights	Error E22: Max. Filltime	Water supply obstructed/shut-off valve closed/water pressure too low.	Inspect water supply (filter, water piping, etc.), check/open shut-off valve, check water pressure.
				Inlet valve blocked or defective.	Inspect strainer insert in the inlet valve, if applicable clean strainer insert or replace inlet valve.
				Excessive back pressure in the steam line (pressure in steam bath cabin too high, steam line too long or kinked), causing water loss via filling cup.	Check pressure in steam bath cabin, inspect steam installation.
				Leakage in the water system.	Inspect water system and seal if necessary.

Warning		Error		Cause	Remedy
LED	Display	LED	Display		
No electrode current for more than 20 minutes		No electrode current for more than 4 hours			
—	Warning W23: No Current	red lights	Error E23: No Current	Phase failure heating voltage.	Inspect/turn on service switch of the mains supply line. Inspect the fuses of the mains supply, replace if necessary. Check/replace main contactor.
				Water supply obstructed/shut-off valve closed/water pressure too low.	Inspect water supply (filter, water piping, etc.), check/open shut-off valve, check water pressure.
				Inlet valve blocked or defective.	Inspect strainer insert of the inlet valve, if applicable clean strainer insert or replace inlet valve.
				Excessive back pressure in the steam line (pressure in steam bath cabin too high, steam line too long or kinked), causing water loss via filling cup.	Check pressure in steam bath cabin, inspect steam installation.
				Leakage in the water system.	Inspect water system and seal if necessary.
Electrode current in relation to the steam demand too high		Electrode current in relation to the steam demand too high			
—	Warning W24: Over Current	red lights	Error E24: Over Current	Humidity demand has decreased too fast.	Automatic adaptation of the operating point.
				Drain pump defective.	Inspect drain pump, replace if necessary.
				Drain in steam cylinder blocked.	Replace steam cylinder.
				Water conductivity too high for the selected steam cylinder type.	Select correct steam cylinder type.
Max. admissible electrode current exceeded		Max. admissible electrode current exceeded			
—	Warning W25: Excess Current	red lights	Error E25: Excess Current	Drain pump defective.	Inspect drain pump, replace if necessary.
				Drain in steam cylinder blocked.	Replace the steam cylinder.
				Water conductivity too high for the selected steam cylinder type.	Select correct steam cylinder type.
		Relay heating voltage jammed			
—	—	red lights	Error E26: Req.Off Current	Relay heating voltage jammed in activated position.	Inspect relay, replace if necessary.
Foam detection		Foam detection (4 automatic drainings within 24 hours)			
—	Warning W27: Foam	red lights	Error E27: Foam	Foaming in steam cylinder.	Drain steam cylinder via drain key (several times, if necessary). Check quality of the supply water.
Steam cylinder needs service		Service interval for steam cylinder exceeded			
yellow lights	Warning W28: Cyl. Maintenance	red and yellow flash	Error E28: Cyl. Maintenance	Mineral deposits and/or electrodes spent.	Replace steam cylinder. Important: After replacement of the steam cylinder, reset the maintenance counter (see chapter 6.6).
Steam cylinder needs service		Max. operating hours of the steam cylinder reached			
yellow lights	Warning W29: Cyl. Maintenance	red and yellow flash	Error E29: Cyl. Maintenance	Maximum operating hours of the steam cylinder reached.	Replace steam cylinder. Important: After replacement of the steam cylinder, reset the maintenance counter (see chapter 6.6).

Warning		Error		Cause	Remedy
LED	Display	LED	Display		
Temperature or humidity sensor signal missing		Temperature or humidity sensor signal missing for more than 1 minute			
—	Warning W32: Sensor void	red lights	Error E32: Sensor void	No sensor signal present at signal input.	Check sensor , replace if necessary. Inspect wiring.
Standby mode of steam cylinder active		Standby mode of steam cylinder failed			
—	Warning W36: Idle Mode active	red lights	Error W36: Idle Mode failed	Automatic standby operation (Standby-Drain, AntiFreeze, KeepWarm) of steam cylinder active or failed.	Warning status: No measures must be taken. Error status: Check water supply, heating voltage supply, main contactor.
Forced draining of steam cylinder active					
—	Warning E37: Forced Drain	—	—	Forced draining of steam cylinder active.	No measures must be taken.

7.3 *Faults without fault indication*

Fault	Cause	Remedy
The display is dark and the unit switch is not illuminated though it is switched on.	The external service switch of the control voltage supply not switched on.	Switch on the external service switch of the control voltage supply.
	Thermal relay has triggered. The red reset key on the thermal relay protrudes.	Check thermal relay in the control compartment. Before pushing in the reset key (reset) at the thermal relay let have the relay settings and the system be checked by a trained service technician.

7.4 **Notes on fault elimination**



DANGER!
Danger of electric hazard!

For the elimination of faults **set the steam generator out of operation** as described in chapter 4.4, **separate the unit from the mains** and **secure it against inadvertent power-up**.

The elimination of faults must be carried out by qualified and well trained professionals only.

Malfunctions relating to the electrical installation (e.g. replacement of the backup battery, replacement of fuses) must be repaired by authorized personnel or by your Nordmann representative's service technician only.

Repair work and the replacement of faulty components must be carried out by your Nordmann representative's service technician only!

7.5 **Resetting the error indication (red LED lights)**

To reset the error indication:

Disconnect the steam generator from the mains. Wait approx. 5 seconds, then reconnect the unit to the mains.

Note: If the fault has not been eliminated, the error indication reappears after a short while.

7.6 Replacing the backup battery on the control board

1. Set the Nordmann AT4 D out of operation as described in chapter 4.4, disconnect it from the mains and secure the unit against inadvertent power-up.
2. Undo the screw of the front cover of the control compartment, then remove the front cover.

CAUTION!

The **electronic components** inside the steam generator are **very sensitive to electrostatic discharge**. Before carrying out the next step, appropriate **measures must be taken to protect the electronic components against damage caused by electrostatic discharge (ESD protection)**.

3. Carefully lift-off the display and control unit from the housing frame, swivel it 90° to the left, then fix it to the unit frame again.
4. Undo the fastening screws of the control board, then carefully pull-off the control board from the control unit assembly.

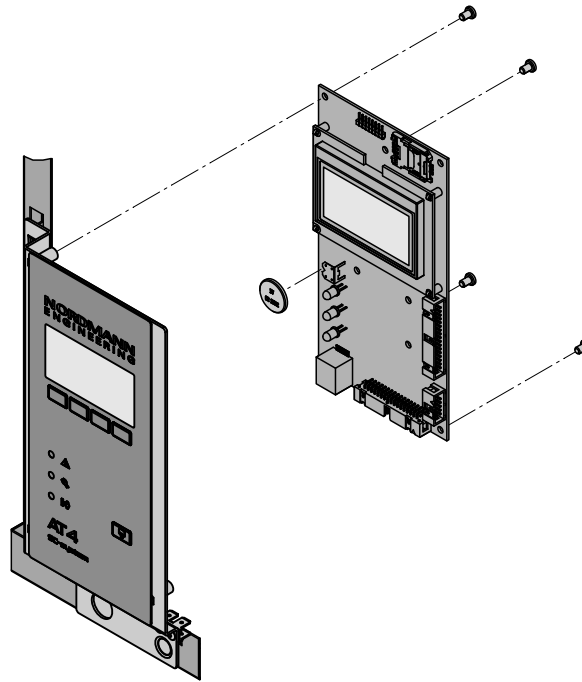

5. Replace the backup battery (CR2032, Lithium 3V).
6. Reassemble the unit in reverse order.
7. If necessary set date and time (see chapter 5.3.8 and 5.3.9).



WARNING! Environmental hazard!



The old battery must be returned to an authorised collecting point for correct disposal/recycling in accordance with local regulations. In no case the old battery must be disposed of in the domestic waste or into the environment.

8 Taking out of service/Disposal

8.1 Taking out of service

If the Nordmann AT4 D must be replaced or if the humidification system is not needed any more, proceed as follows:

1. Take the unit out of operation as described in chapter 4.4.
2. Have the unit (and all other system components, if necessary) unmounted by a qualified service technician.

8.2 Disposal/Recycling



Components not used any more must not be disposed of in the domestic waste. Please dispose of the unit or the individual components in accordance with local regulations at the authorised collecting point.

If you have any questions, please contact the responsible authority or your local Nordmann representative.

Thank you for your contribution to environmental protection.

9 Product specifications

9.1 Technical data

Steam capacity in kg/h	5	8	15	23	32	45	65
Capacity range in kg/h	1...5	1.6...8	3...15	4,6...23	6,4...32	9...45	13...65
Nominal power in kW	3,8	6,0	11,3	17,3	24,0	33,8	48,8
Heating voltage 230V/1~/50..60Hz *							
Unit model	522	822					
Nominal current in A	16,3	26,1					
Steam cylinder type **	522A	822A					
Heating voltage 400V/2~/50..60Hz *							
Unit model	524	824					
Nominal current in A	9,4	15,0					
Steam cylinder type **	524A	824A					
Heating voltage 230V/3~/50..60Hz *							
Unit model	532	832	1532	2362	3262		
Nominal current in A	9,4	15,1	28,2	43,3	60,2		
Steam cylinder type **	532A	832A	1532A	2362A	3262A		
Heating voltage 400V/3~/50..60Hz *							
Unit model	534	834	1534	2364	3264	4564	6564
Nominal current in A	5,4	8,7	16,2	24,9	34,6	48,7	70,4
Steam cylinder type **	534A	834A	1534A	2364A	3264A	4564A	6564A
Steam cylinder type ***	534A-L	834A-L	1534A-L	2364A-L	3264A-L	4564A-L	---
Control voltage	200-240 V/1~/50..60 Hz						
Operating conditions							
Admissible water pressure	1...10 bar						
Water quality	Untreated drinking water with a conductivity of 125...1250 µS/cm						
Admissible water temperature	1...40 °C						
Admissible ambient temperature	1...40 °C						
Admissible ambient humidity	max. 75 %rF (non condensing)						
Admissible air pressure in the steam bath cabin	-0.8 kPa...1.5 kPa						
Type of protection	IP21						
Conformity	CE, VDE, GOST						
Dimensions/Weights							
Width in mm	428	428	508	508	563	563	563
Height in mm	575	575	620	620	640	640	640
Depth in mm	255	255	345	345	354	354	354
Net weight in kg	12		19		28		30
Operating weight in kg	17		29		65		67
Water supply connector	G 3/4" (male thread)						
Water drain connector	ø 31 mm (outside diameter)						
Steam connector	1x ø 22		1x ø 35			2x ø 35	
Options							
Cable gland	1x CG						
Steam hose connector with condensate trap	1x CT22		1x CT35			2x CT35	
Internal control voltage supply	1x S-CVI			1x M-CVI			1x L-CVI
@Link AT4 D	@Link AT4 D						
Accessories							
Filter valve	1x Z261						
Nordmann AT4 D Remote Terminal	RP						
Nordmann AT4 D Touch Screen Panel	TSP						
Temperature sensor KTY	KTY						
Steam distributor	1xW22		1xW35			2xW35	
Fragrance pump	1xFP 240V						
T-piece for fragrance injection	1xTSD22		1xTSD35			2xTSD35	
Steam hose / meter	1xDS22		1xDS35			2xDS35	
Condensate hose / meter	KS10						
Condensate drain	1xCD22		1xCD35			2xCD35	
EcoTherm insulation hose	1xECT22		1xECT60			2xECT60	
50-210VA transformer for 4x50W lamps	TRL						

* Other heating voltages on request

** Steam cylinder for water conductivity from 125 to 1250 µS/cm (standard version)

*** Steam cylinder for low water conductivity from 80 to 125 µS/cm

9.2 Wiring diagram Nordmann AT4 D

Jumper settings for operation with optional remote terminal **		
Jumper	Remote terminal	Unit(s) in between
JP1	1200 end resistor	X
JP4	Pull up resistor	X
JP5	Pull down resistor	X

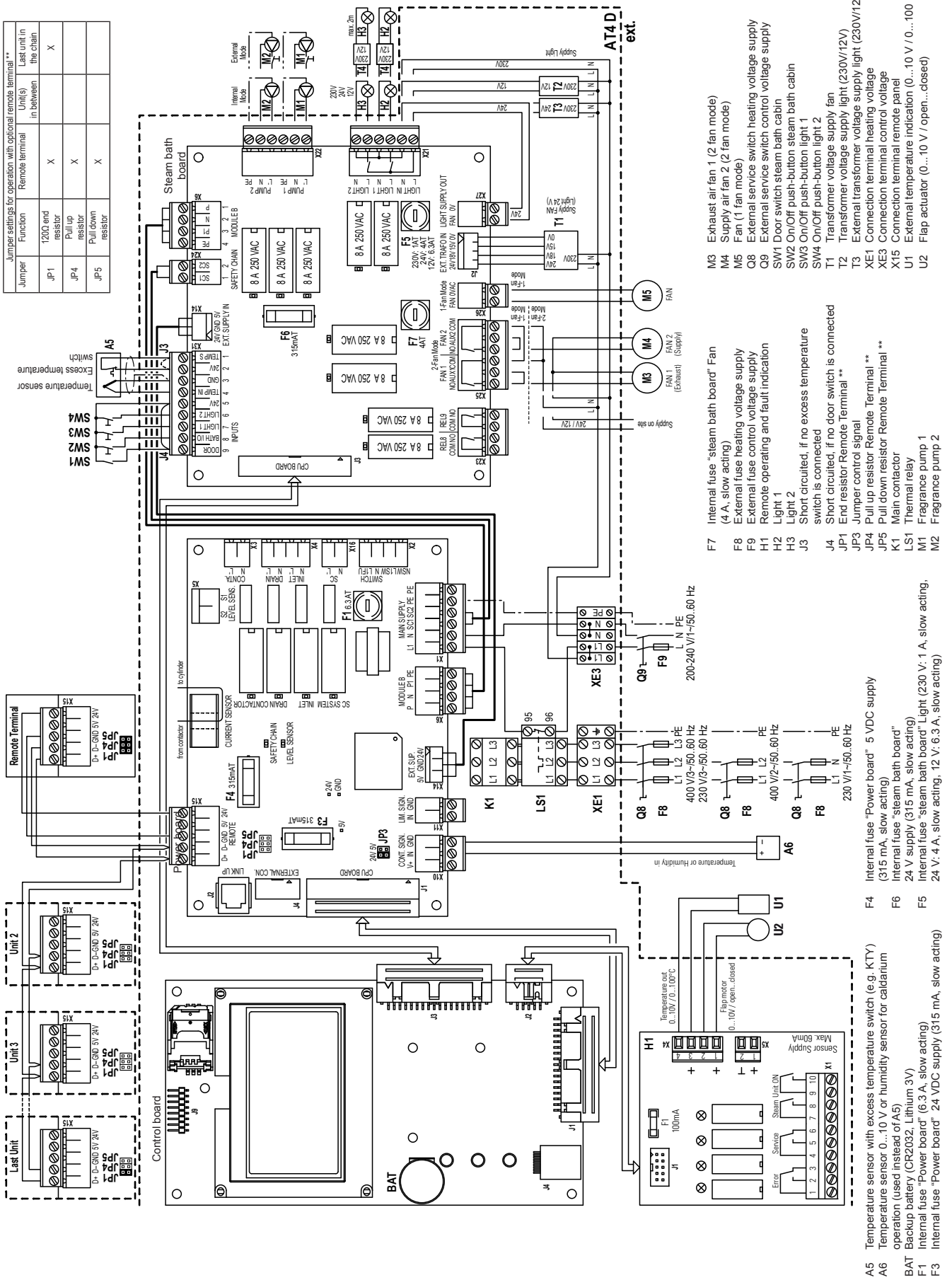

- A5 Temperature sensor with excess temperature switch (e.g. KTY) operation (used instead of A5)
- BAT Backup battery (CR2032, Lithium 3V)
- F1 Internal fuse "Power board" (6.3 A, slow acting)
- F3 Internal fuse "Power board" 24 VDC supply (315 mA, slow acting)
- F4 Internal fuse "Power board" 5 VDC supply (315 mA, slow acting)
- F6 Internal fuse "steam bath board"
- F5 Internal fuse "steam bath board" "Light" (230 V; 1 A, slow acting, 24 V; 4 A, slow acting, 12 V; 6.3 A, slow acting)
- H1 Temperature out. 0...10V/0...100°C
- F1p1 100mA
- F1p2
- F1p3
- F1p4
- F1p5
- F1p6
- F1p7
- F1p8
- F1p9
- F1p10
- F1p11
- F1p12
- F1p13
- F1p14
- F1p15
- F1p16
- F1p17
- F1p18
- F1p19
- F1p20
- F1p21
- F1p22
- F1p23
- F1p24
- F1p25
- F1p26
- F1p27
- F1p28
- F1p29
- F1p30
- F1p31
- F1p32
- F1p33
- F1p34
- F1p35
- F1p36
- F1p37
- F1p38
- F1p39
- F1p40
- F1p41
- F1p42
- F1p43
- F1p44
- F1p45
- F1p46
- F1p47
- F1p48
- F1p49
- F1p50
- F1p51
- F1p52
- F1p53
- F1p54
- F1p55
- F1p56
- F1p57
- F1p58
- F1p59
- F1p60
- F1p61
- F1p62
- F1p63
- F1p64
- F1p65
- F1p66
- F1p67
- F1p68
- F1p69
- F1p70
- F1p71
- F1p72
- F1p73
- F1p74
- F1p75
- F1p76
- F1p77
- F1p78
- F1p79
- F1p80
- F1p81
- F1p82
- F1p83
- F1p84
- F1p85
- F1p86
- F1p87
- F1p88
- F1p89
- F1p90
- F1p91
- F1p92
- F1p93
- F1p94
- F1p95
- F1p96
- F1p97
- F1p98
- F1p99
- F1p100

Notes

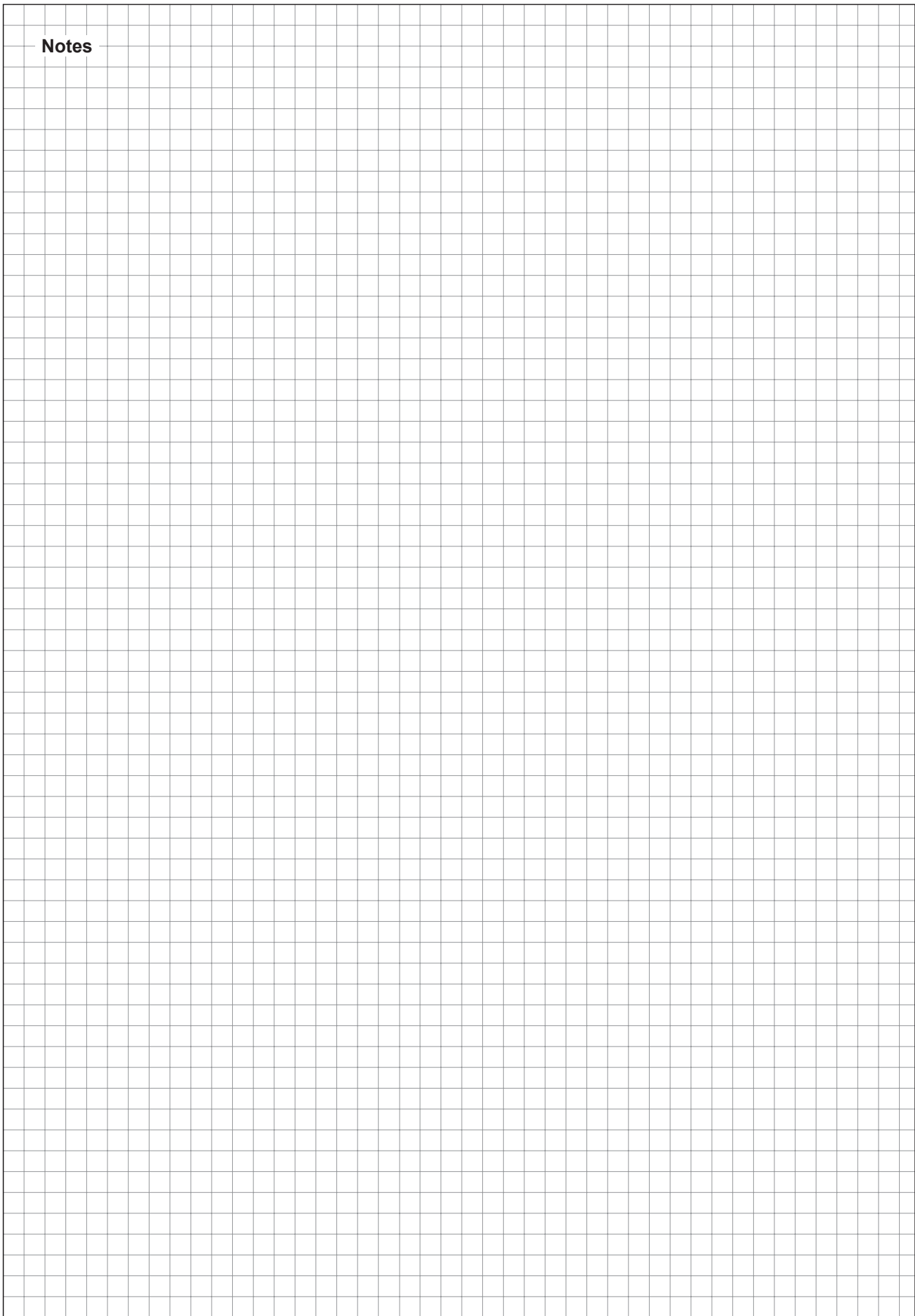

Notes

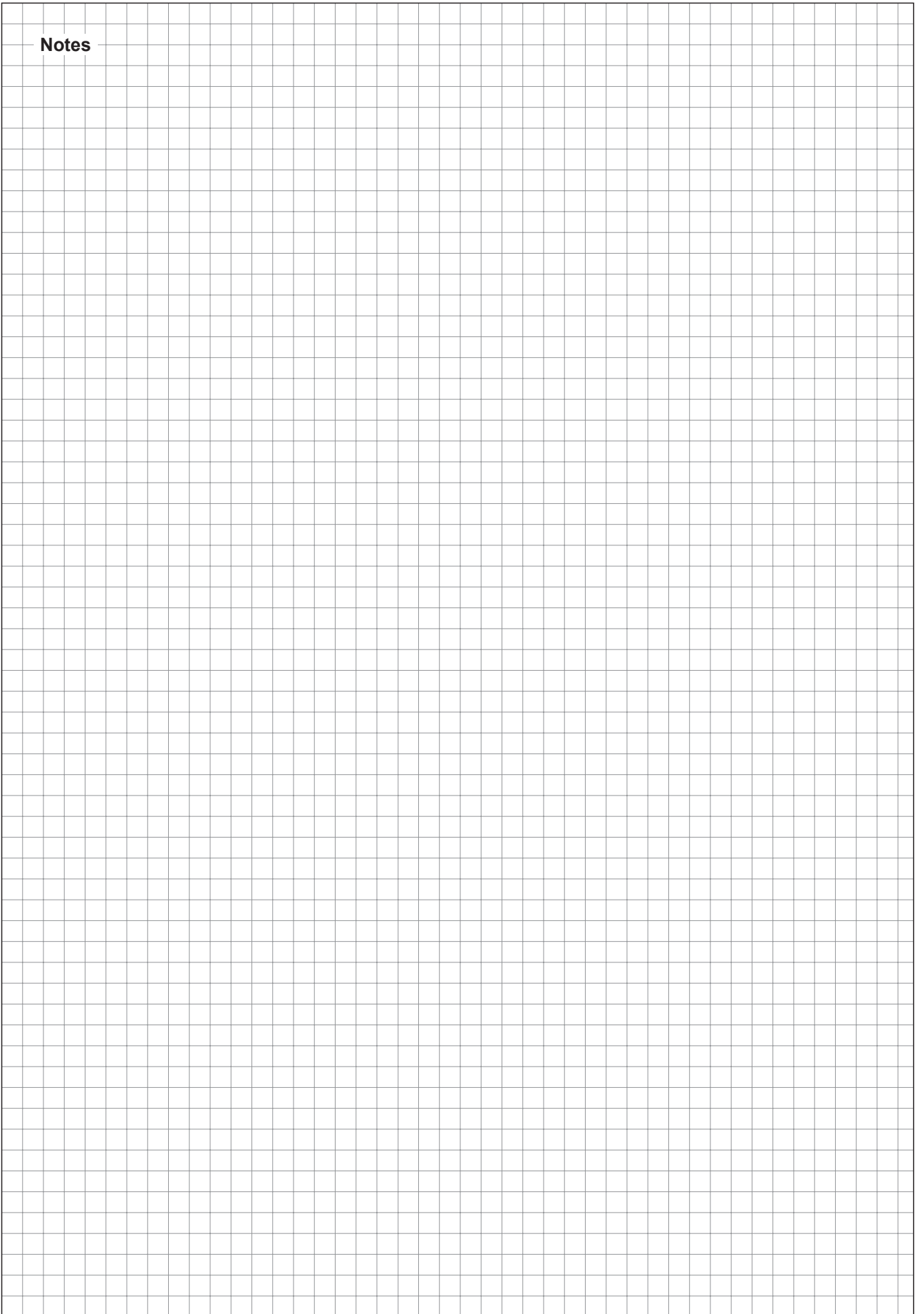

Notes

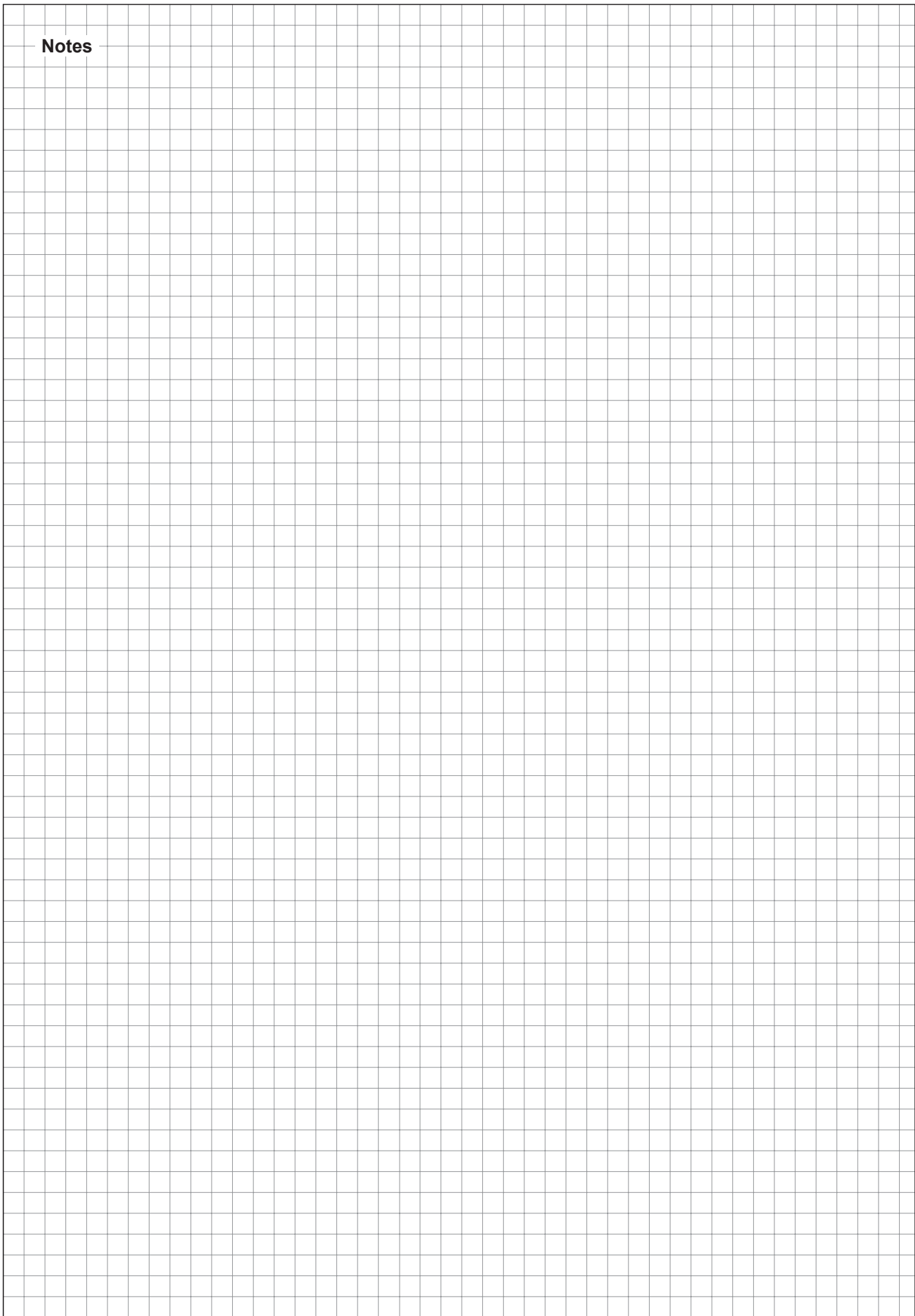



CH94/0002.00

Condair Group AG
Gwattstrasse 17, 8808 Pfäffikon SZ, Switzerland
Phone +41 55 416 61 11, Fax +41 55 588 00 07
info@condair.com, www.condairgroup.com